



# ZF CVCS PRODUCT CATALOGUE - 2023

Amar Singh

Mob no : 9914720081

Email : [amar.yadav@zf.com](mailto:amar.yadav@zf.com)



AFTERMARKET



# Use Only ZF (WABCO) Genuine Spares In Air Brake System



# Contents

SL.No	Contents	Page No
1	Schematic Brake Layout	4
2	160cc Air Compressor	5 to 8
3	230cc Air Compressor	9 to 11
4	318cc Air Compressor	12 to 13
5	393cc Air Compressor	14
6	Industrial Air Compressor	15
7	Compressor Head	16 to 20
8	Modified Piston rings	21
9	Comp Block Kits	22
10	Air Dryer	23 to 24
11	DDU Assy	25 to 26
12	APDA	27 to 29
13	ASP Dryer	30
14	APU	31 to 32
15	Air Processing KB Equivalent	33
16	Unloader Valve	34
17	Oil Separator	35
18	Hand Brake Valve	36 to 40
19	4 inch Clutch Servo	41 to 42
20	3 inch Clutch Servo	43
21	Eicher 3 inch Servo	44
22	3.5 inch Clutch Servo	45
23	Clutch Master Cylinder	46
24	Vacuum Booster	47
25	IPU	48 to 50
26	Brake Chamber	51
27	Spring Brake Actuator	52 to 61
28	Dual Brake Valve	62 to 63
29	SL & LP Switch	64
30	QSPV	65

SL.No	Contents	Page No
31	RG2 Relay Valve	66 to 67
32	Relay Valve Package	68
33	R12 & R14 Relay Valve	69
34	TCV, IRV & Re6 Relay Valve	70
35	QRV, PRV & Palm Coupling	71
36	ALSV	72
37	LDV & LACV	73
38	Brake Hose	74 to 78
39	Connectors & Voss Fittings	79 to 80
40	MSA	81
41	ASA	82 to 83
42	ABS Modulator Valve	84
43	ABS ECU	85
44	ABS Sensor	86
45	Vacuum EBV	87
46	Lever Control Valve	88
47	Air Suspension	89
48	ECAS	90
49	DEF	91
50	RPAS	92
51	ADB	93
52	Magentic Valve	94
53	3/2 Solenoid Valve	95
54	Vacuum pump	96
55	Air Cylinder	97
56	Door Cylinder	98 to 99
57	DBV Switch & Sensor	100
58	Pressure Test Connectors	101
59	Scheme Part numbers	102
60	MOQ Part Numbers	103
61	Competitors Suitable Assy	

# Schematic Brake Layout

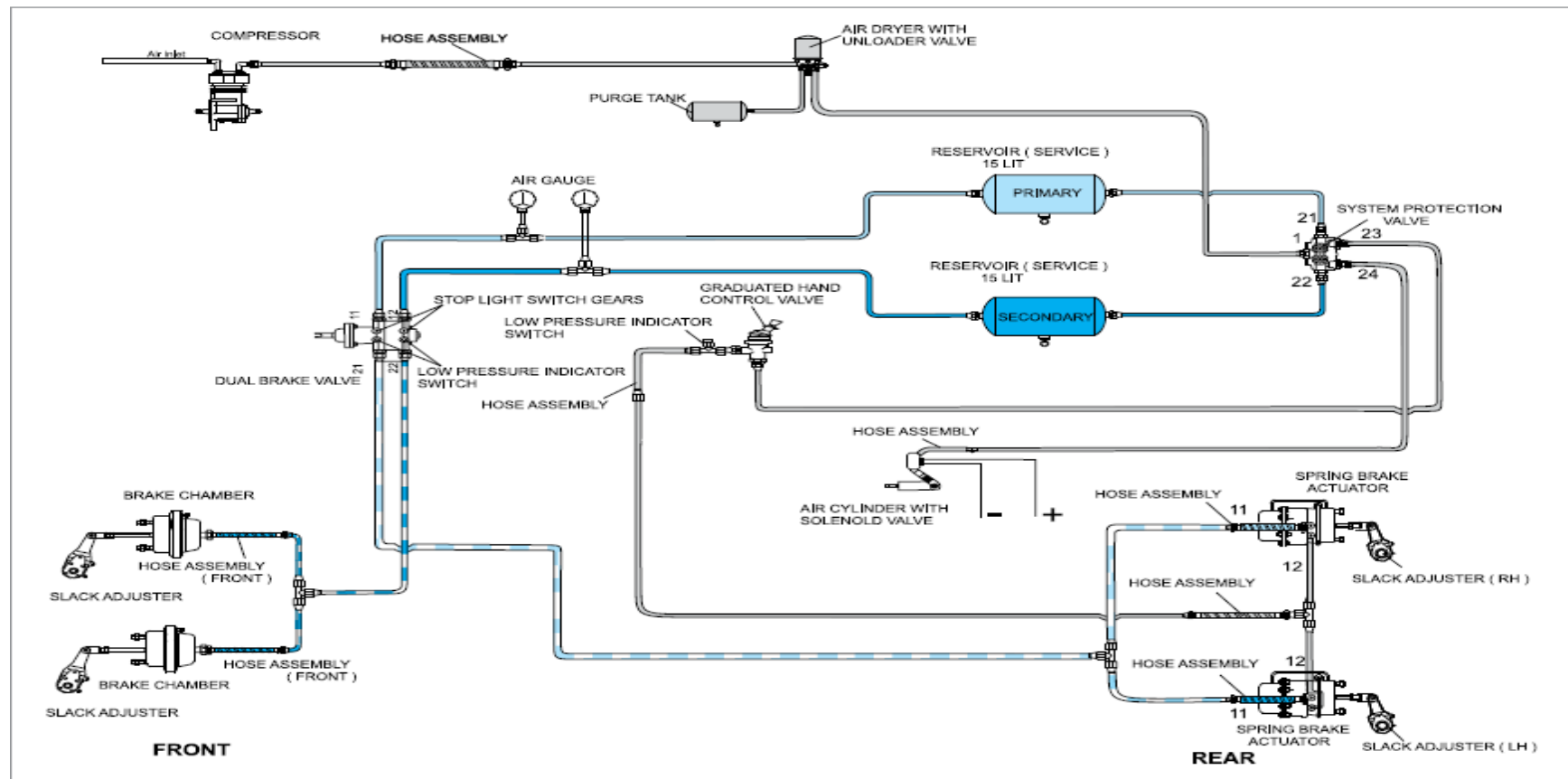



# 160 CC Air compressor



Part No	100100750	100100893	100100840	9129700490	100101020
Descrption	Air compressor	Air compressor	Air compressor	Air compressor	Air compressor
OEM name	AL Hino	Al Ecomet	AL Boss	AL	AL 2516 BSII
Grand Total	728,866	63,563	58,023	725	580
Capacity	160cc	160cc	160cc	160cc	160cc
cooling	air	air	water	air	water
Head Assy	350023005	350023027	350023027	100111720	9129058002
Major kit	300001149	300001193	300001499	300001469	300001300
Minor Kit	300001148	300001185	300001498		300001304
Reed valve assy	100110960	100111160	100111160	100111600	100111790
Reed valve kit	300001208	300001210	300001210		300001302
Rings std	300001509	300001195	300001509	300001487	300001487
Rings 1st	300001510	300001200	300001510	300001227	300001227
Rings 2nd	300001511	300001201	300001511	300001228	300001228
Piston (Std)	350024099	300001194	350024099	300001223	300001223
Piston 1st	NA	300001198	NA	300001224	300001224
Piston 2nd	NA	300001199	NA	300001225	300001225
Crank case kit	350023012	350023023	350023012		350023014
con rod	100110990	100111360	100110990		100135881
crank shaft	100133661	100134432	100133661		100135841
Fig	a	b	c	d	e

# 160cc Air compressor Eicher

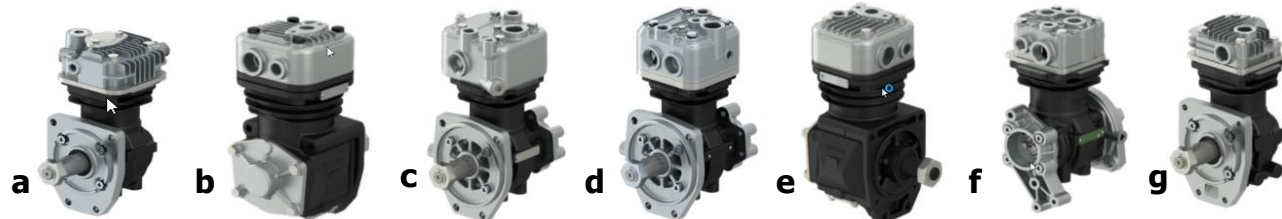

Part No	100101030	100100873	9129700750	9129700140	100100872	9129700130	9129700630	9129700780 9129700360 9129700760	9129700740	9129700730
<b>Type</b>	160cc	160cc	160cc	160cc	160cc	160cc	160cc	160cc	160cc	160cc
<b>cooling</b>	water	air	water	water	air	water	Water	water	air	water
<b>Head Assy</b>	9129058002	350023027	9129700912	9129058002	350023027	9129700012	9129058002	9129700912	9129709292 (23/9)	9129709372
<b>Major kit</b>	300001389	300001193	9129700922	300001496	300001193	300001454	9129709012	9129700902		9129709302
<b>Minor Kit</b>	300001396	300001185		300001497	300001185	300001493	9129709002		9129709282	
<b>Reed valve assy</b>	100111560	100111160	100111560	100111560	100111160	NA	9129709012	9129700902		100111410
<b>Reed valve kit</b>	300001397	300001210			300001210	NA		9129700972		
<b>Rings std</b>	300001487	300001509	300001487	300001487	300001195	300001487	300001487	300001487	300001487	300001487
<b>Rings 1st</b>	300001488	300001510	300001227	300001227	300001200	300001227	300001227	300001227	300001227	300001227
<b>Rings 2nd</b>	300001489	300001511	300001228	300001228	300001201	300001228	300001228	300001228	300001228	300001228
<b>Piston (Std)</b>	300001390	350024099	300001223	300001223	300001194	300001303	9129709022	9129700892	300001223	300001223
<b>Piston 1st</b>	300001391	NA	300001224	300001224	300001198	NA			300001224	300001224
<b>Piston 2nd</b>	300001392	NA	300001225	300001225	300001199	NA			300001225	300001225
<b>Crank case kit</b>	350023020	350023023	9129700942		350023023	100137752				
<b>con rod</b>	100135881	100111360			100111360	9129707314				
<b>crank shaft</b>	100135841	100134432			100134432	9129706974				
<b>Fig</b>	<b>a</b>	<b>b</b>	<b>c</b>	<b>d</b>	<b>e</b>	<b>d</b>	<b>d</b>	<b>c</b>	<b>g</b>	<b>f</b>

# 160 Cc Air compressor TATA

Internal

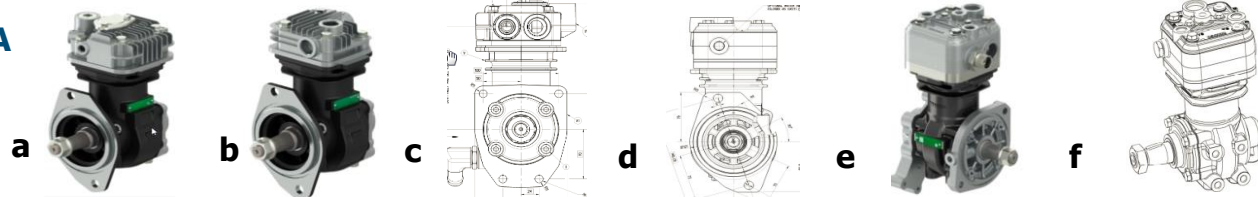

Part No	100101221 100101220	100100961/62 100100960 100100963	100101670	9129700040	100101360	100101270
cooling	air	air	air	water	water	water
Head Assy	100111720/721	350023003 – Top Port 350023004 – Side Port 350023008 – nipple	100111720	9129058002	9129058002	9129058002
Major kit	300001469	300001216	300001469		300001472	300001468
Minor Kit	300001366	300001215	300001366		300001481	300001478
Reed valve assy	100111600	350023009	100111600	100111560	100111560	100110960
Reed valve kit	300001445	300001229			300001421	300001372
Rings std	300001487	300001487	300001487	300001487	300001393	300001487
Rings 1st	300001488	300001227		300001227	300001394	300001427
Rings 2nd	300001489	300001228		300001228	300001395	300001428
Piston (Std)	300001223	300001223	300001417	300001223	300001390	300001303
Crank case kit	350023017	350023013	350023019	350023017	350023020	350023014
con rod	100135581	100110100				100135881
crank shaft	100135561	100130951				100135841
rFig	a	b	c	d	e	f



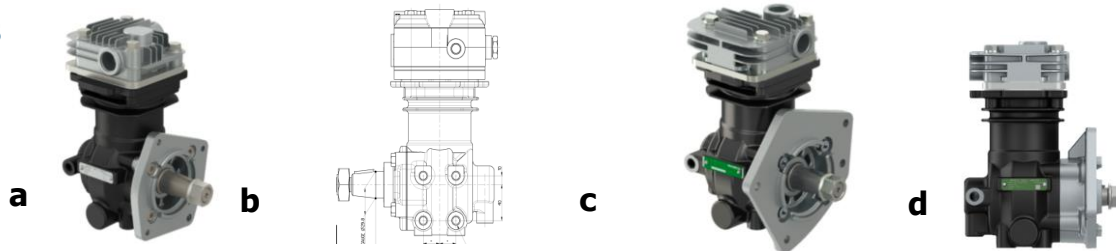

Part No	9129700070	9129700710	100101230	9129700120 / 101480	100100920
<b>Descprition</b>	Air compressor	Air compressor	Air compressor	Air compressor	Air compressor
<b>OEM name</b>	M&M	M&M	M&M	Off highway	Industrial
<b>Grand Total</b>	9,837	1,390	497	15,021	10,440
<b>Type</b>	160cc	160cc	160cc	160cc	160cc
<b>cooling</b>	water	air	air	air	air
<b>Head Assy</b>	9129058002	350023004	350023004	350023003	350023005
<b>Major kit</b>	300001490		300001216		300001197
<b>Minor Kit</b>	300001489		300001215	300001215	300001196
<b>Reed valve assy</b>	NA		100111410	100111410	100110960
<b>Reed valve kit</b>	NA		300001229		
<b>Rings std</b>	300001487	300001487	300001487	300001487	300001195
<b>Rings 1st</b>	300001227	300001227	300001227	300001227	
<b>Rings 2nd</b>	300001228	300001228	300001228	300001228	
<b>Piston (Std)</b>	300001223		300001223	300001223	
<b>Piston 1st</b>	300001224		300001224	300001224	
<b>Piston 2nd</b>	300001225		300001225	300001225	
<b>Crank case kit</b>	350023020			350023021	
<b>con rod</b>	100135881		100110100		
<b>crank shaft</b>	100135841		100130951		
<b>Fig</b>	b	d	c	a	

# 230cc AL Compressor

Internal



a



b

MATERIAL	100100970	100101080	100101590	9129700610
Description	Air compressor	Air compressor	Air compressor	Air compressor
Prodcut Family	Air Compressor	Air Compressor	Air Compressor	Air Compressor
OEM name	ASHOK LEYLAND	ASHOK LEYLAND	ASHOK LEYLAND	ASHOK LEYLAND
Grand Total	262,467	82,601	30,867	774
Type	230cc	230cc	230cc	230cc
cooling	Air	water	water	water
Head Assy	9129709342	9129709332	9129709332	9129709332
Major kit	300001306	300001475	300001361	300001361
Minor Kit	300001305	300001486	300001486	300001486
Reed valve assy	100111230	912979322	912979322	912979322
Reed valve kit		300001446	300001446	300001446
Rings std	300001509	300001509	300001509	300001509
Rings 1st	300001510	300001510	300001510	300001510
Rings 2nd	300001511	300001511	300001511	300001511
Piston (Std)	350024099	350024099	350024099	350024099
Piston 1st	NA	NA	NA	NA
Piston 2nd	NA	NA	NA	NA
Crank case kit				
con rod				
crank shaft				
Fig	a	b	b	b

## 230cc Water Cooled – TATA Motors



a



b



c

d

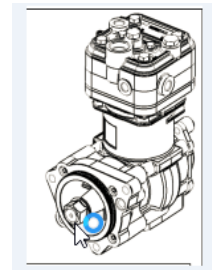

Internal

MATERIAL	9129700180 – Side Port 9129700170 – Top Port 9129700390- Side port	100101170	9129700090	9129700020	9129700060
Head Assy	9129709382 – Side Port 9129709332 – Top Port	100112000	350023051	9129709332	350023051
Major kit	300001477	300001310	300001345	9129700762	300001505
Minor Kit	300001486	300001485	300001503		300001503
Reed valve assy	9129709322	9129709322		9129709322	
Reed valve kit	300001446			300001446	
Rings std	300001509	300001509	300001509	300001509	
Rings 1st	300001510	300001510	300001510	300001510	
Rings 2nd	300001511	300001511	300001511	300001511	
Piston (Std)	350024099	350024099	350024099	350024099	
Crank case kit con rod crank shaft	350023016		350023016	350023016	
Fig	a	d	b	a	c

# 230cc Air compressor

a



b



c

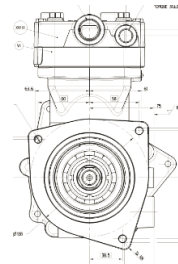

<b>MATERIAL</b>	<b>9129700560</b>	<b>100101600</b>	<b>9129700650</b>
<b>Description</b>	Daimler – 1214 (LCV)	MNAL	230cc MTBL Compressor
<b>OEM name</b>	Daimler - India	M&M	M&M
<b>Grand Total</b>	56,559	43,890	5,295
<b>Type</b>	230cc	230cc	230cc
<b>cooling</b>	water	water	water
<b>Head Assy</b>	350023051	9129709382	9129638002
<b>Major kit</b>	300001403		9129700752
<b>Minor Kit</b>			
<b>Reed valve assy</b>			
<b>Reed valve kit</b>			
<b>Rings std</b>	300001404	300001509	300001509
<b>Rings 1st</b>		300001510	300001510
<b>Rings 2nd</b>		300001511	300001511
<b>Piston (Std)</b>		350024099	350024099
<b>Crank case kit</b>			
<b>con rod</b>			
<b>crank shaft</b>			
<b>Fig</b>	<b>a</b>	<b>b</b>	<b>c</b>

# AL 318 CC Air Compressor

Internal

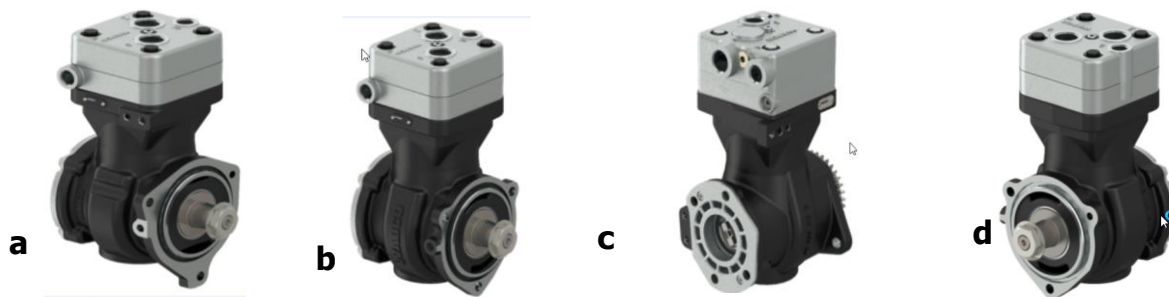

MATERIAL	9121700030	9121700040 – Top port Inlet / delivery	9121700010	9121700050	9121700000
<b>Description</b>	Compressor Hino	Compressor Assembly Neptune	One-Cylinder Compressor	Compressor Neptune	Compressor
<b>Type</b>	318cc	318cc	318cc	318cc	318cc
<b>cooling</b>	Water	water	water	Water	water
<b>Head Assy</b>	9121709242	9121709202	9121709242	9121708032	
<b>Major kit</b>	300001538		300001538		
<b>Minor Kit</b>	300001537		300001537		
<b>Reed valve kit</b>			9121709232		
<b>Rings std</b>	300001411	300001411	300001411	300001411	300001411
<b>Std piston</b>	300001409	300001409	300001409	300001409	300001409
<b>Rear End cover</b>	9121706004		9121706004		
<b>Piston 2nd</b>					
<b>Crank case kit</b>	9121706914		9121700122	9121700162	
<b>con rod</b>	9120007452		9120007372	9120007452	
<b>crank shaft</b>	9121796904		9121706914	9121796954	
<b>Fig</b>	<b>a</b>	<b>c</b>	<b>b</b>	<b>c</b>	<b>d</b>



## TATA 318 CC Air compressor Assy

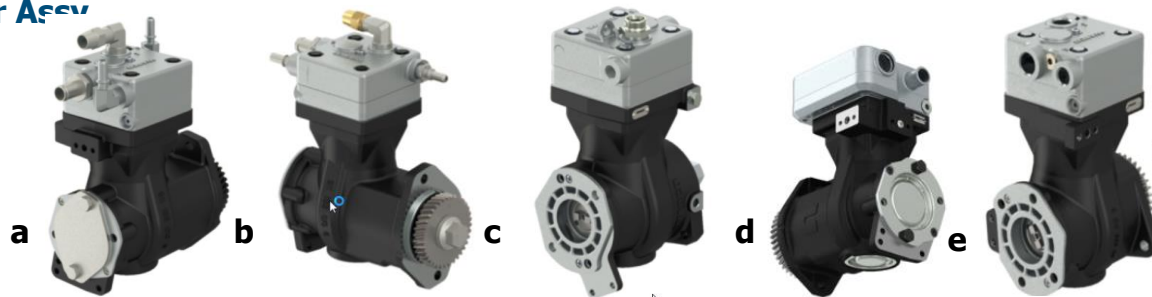



MATERIAL Fig	9121400130	9121400320	9121790010	9111539380	9111535520	9121400500	9121790040	9121790030	9121790020
Head Assy	9111558042	9111558042	9121796522	9111539202	9111558042	9121408182	9121799282		9121799272
Major kit	300001408	300001408		9111549292	318cc				
Minor Kit					water				
Reed valve kit									
Rings std	300001411	300001411	300001411	300001411		300001411	300001411	300001411	300001411
StD piston	300001409	300001409	300001409	300001409		300001409	300001409	300001409	300001409
Rear End cover		9111556604			9111536074				
Piston 2nd				300001411	300001411				
Crank case kit con rod	9121400192	350023030	9121790112	300001409	300001409	9121400192			
crank shaft	9111537342	9121407302	9120007452			9121407302			
Fig	a	b	c	d	e	b	c	c	e

9111535540 and 9111535520 were replaced by 9121400580



# Air Compressor – 393cc (Only TATA)



Part No	Part No	Remarks	Cyl Head Assy	Figure
	(Equivalent)			
8840556640	9122400000	Comp Assy - Cowl	9122409222	
8840561220	9122400010	Comp Assy - Cab	9122409242	

Kit part No	Description	Remarks
9122409202	Major Kit	
9122409212	Valve plate Kit	
9122409222	Cyl Head Kit	for 9122400000 only
9122409232	Repair Kit	
9122409242	Cyl Head Kit	for 9122400010 only
9120007362	Conn rod assy	
9122406914	Crank shaft - lapping	
9122408022	Cyl head assy	
9120006232	Piston assy	

# M100920 Air compressor - Industrial

Internal

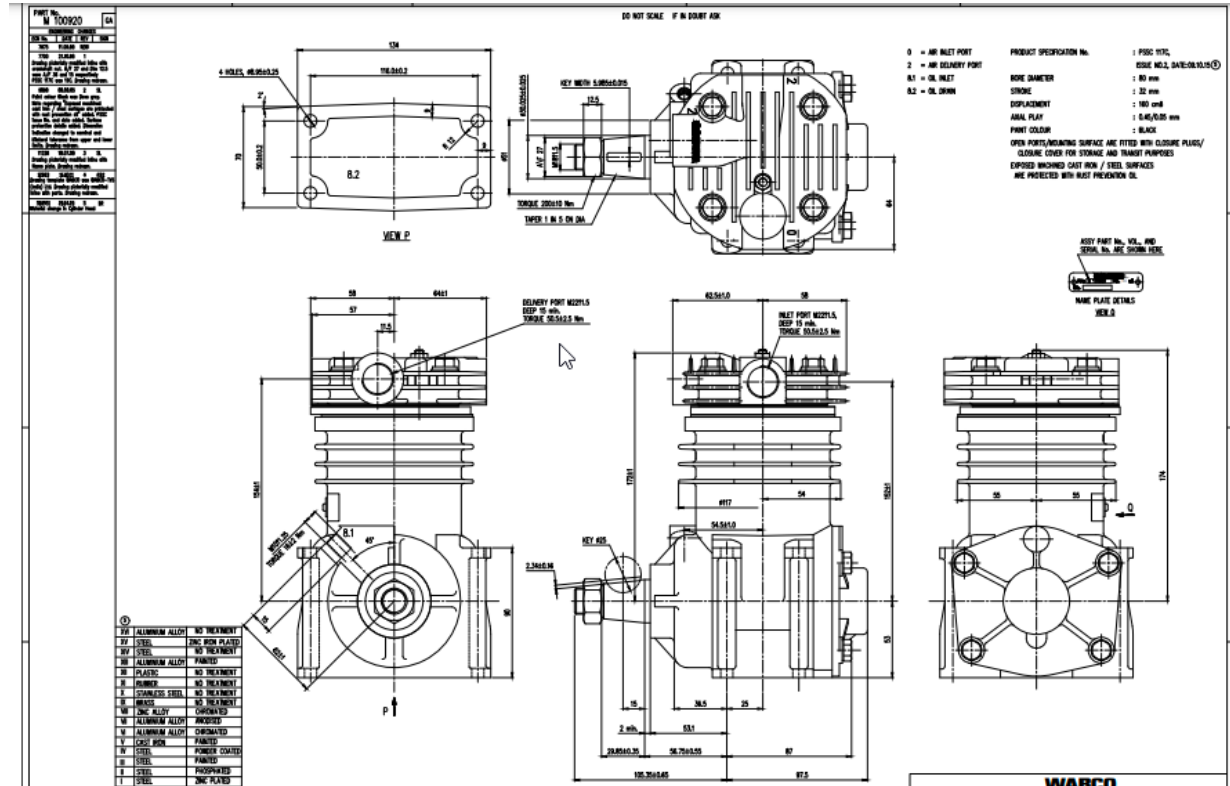

# Compressor Head application







Part Number	Application
100111500	Tata 690 Engine
100111530	AL, TATA WC head w/o PR
100111570	AL, TATA WC head with PR
100111800	TATA NLC HEAD
100112000	MAN 230cc WC
100111720 / 721	Tata 2518
350023000	Tata 697 Engine
350023001	Tata 497 Engine
350023002	Tata 1210
350023003	TC top port
350023004	TC Side Port
350023005	AL Hino
350023006	AL 400 SERIES ENGINE
350023008	MIK23/3 with nipple
350023027	AL Ecomet,Boss, Mazda,Eicher
350023039	AL, TATA WC head w/o PR
350023042	TATA NLC HEAD
350023048	AL BS4 (M100970)
350023051	Tata 1613 Bs4, Daimler 1214
4111548002	Daimler 1623,2523,3123,3128 & 3723
4127049372	Volvo multi axle
9111539202	Tata 3138 BS3
9111558042	Tata Prima
9121108002	BB HDT COMP HEAD
9121109212	Bharat benz 318 cc
9121408182	Tata 1822 & 1869 BS6
9121708032	AL Neptune Engine
9121709202	AL Neptune Engine (N2825Tipper)

Part Number	Application
9121709242	AL BS6(1920H, 1920T, 2820H,2820T, U2820T, U2820RMC, U3520T, 3520H, 4220T, 4020TT, 4220H)
9121796522	Tata Signa 2821 K Bs6
9121798002	3118 BSIV
9121799272	MHCV CNG Bus
9121799282	LPO 1618, 1662 Bs6
9122409222	393 cc Cowl Comp Head
9122409242	393 cc Cab comp head
9129058002	AL 2516 bs2
9129638002	M&M ICV 230cc Head
9129700912	Eicher E483/474, Pro2072/Pro2065T/Pro2065D/VE2011/Pro2011T/Pro2065S,
9129708012	DICV 914R, 1214R, 1217C,1217R, 1617R, BUS 914
9129708052	Eicher 20.15LPO, PRO5016 CAB, PRO 5016T, PRO 5016R, PRO5031 CAB, PRO5025 COWL, PRO 5035 TT
9129709292	Eicher
9129709332	AL, TATA WC head w/o PR
9129709342	AL BS4 (M100970)
9129709372	LPT 1918 cowl
9129709382	Tata, Mahindra WC head





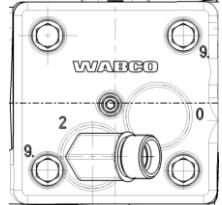

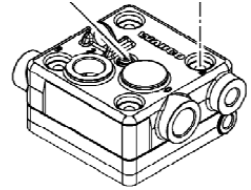



# Compressor Cylinder Head's

<p><b>100111500</b></p> 	<p><b>9129708052</b></p> 	<p><b>9121798002</b></p> 	<p><b>350023027</b></p> 
<p><b>100111720</b></p> 	<p><b>350023000 / M111210</b></p> 	<p><b>350023001</b></p> 	<p><b>350023002</b></p> 
<p><b>350023003(Top port)</b></p> 	<p><b>350023004(Side port)</b></p> 	<p><b>350023005</b></p> 	<p><b>M111530 / 350023039 / 9129709332 (Top port)</b></p> 

# Compressor Cylinder Head's

<p><b>350023048/9129709342</b></p> 	<p><b>9111558042</b></p> 	<p><b>4111548002</b></p> 	<p><b>9122409242</b></p> 
<p><b>9122409222</b></p> 	<p><b>9129708012</b></p> 	<p><b>9129058002(160cc)</b></p> 	<p><b>9121796522</b></p> 
<p><b>9111539202</b></p> 	<p><b>9121408182</b></p> 	<p><b>9121799282</b></p> 	<p><b>9121799272</b></p> 

# Compressor Cylinder Head's

<p><b>9121709242</b></p> 	<p><b>9121709202</b></p> 	<p><b>9121708032</b></p> 	<p><b>350023051</b></p> 
<p><b>9129709382(side port)</b></p> 	<p><b>9129638002</b></p> 	<p><b>100112000</b></p> 	<p><b>350023008</b></p> 
<p><b>9129700912</b></p> 	<p><b>9129709292</b></p> 	<p><b>9129709372</b></p> 	<p><b>100111570 (with PR)</b></p> 



# Compressor Cylinder Head's

350023006



9121108002 (238CC)



4127049372



9121109212



# MODIFIED COMPRESSOR PISTONS

EXISTING



Existing Ring Pack

Piston with Ring Assy no:MSP 1/194

S.No	Part No	Description
1	MSP 1/488	Piston rings ( Std)
2	MSP 1/200	Piston rings ( 1st O/ Z)
3	MSP 1/201	Piston rings ( 2nd O/ Z)

NEW

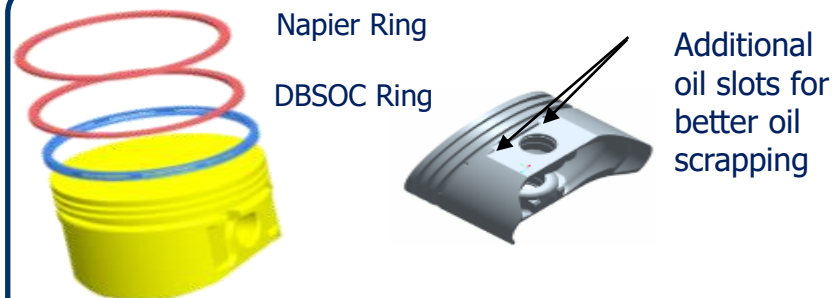

New ring pack

Piston with Ring assy :MIK 24/99

S.No	Part No	Description
1	MSP 1/509	Piston rings ( Std)
2	MSP 1/510	Piston rings ( 1st O/ Z)
3	MSP 1/511	Piston rings ( 2nd O/ Z)

# 318CC Cylinder Block Kit

Assembly Number - 318 cc	Crank Case Assy Part No	Description	MRP	Application
9121400130 9121400180	9121409222	318 cc Crankcase Kit	14696	TATA CUMMINS
9121400060 9111535520 9111535540	9111539472	318 cc Crankcase Kit	14696	TATA CUMMINS
9121790000	9121799292	318 cc Crankcase Kit	14696	M&M
9121100010 9121100000	9121109262	318 cc Crankcase Kit	14696	Bharat Benz
9121400580	9121409232	318 cc Crankcase Kit	14696	TATA CUMMINS
9121700030	9121709262	318 cc Crankcase Kit	14696	Ashok Leyland Hino Engine

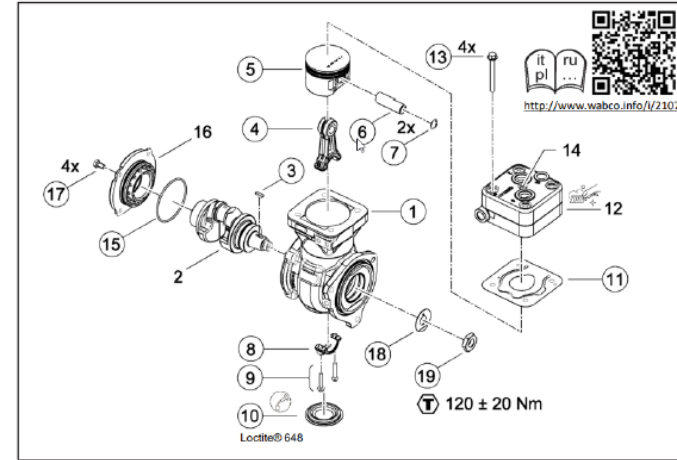

Part Number	Description	Major Kit	Minor Kit
100303470	AIR DRYER	300003075 / 71 /165	300003078
100303472	AIR DRYER	300003075 / 71 /165	300003078
100303510	AIR DRYER	300003075 / 71 /165	300003078
100303512	AIR DRYER	300003075 / 71 /165	300003078
100303517	AIR DRYER	300003075 / 71 /165	300003078
100304730	AIR DRYER	300003075 / 71 /165	300003078
100305870	AIR DRYER Voss	300003165	300003078
100306900	AIR DRYER Voss	300003165	300003078
100306910	AIR DRYER Voss	300003165	300003078
100307110	AIR DRYER Voss	300003165	300003078
100307120	AIR DRYER Voss	300003165	300003078
100307560	AIR DRYER Voss	300003165	300003078
100307610	AIR DRYER Voss	300003165	300003078
100308170	AIR DRYER Voss	300003165	300003078
100308370	AIR DRYER Voss	300003165	300003078
100308500	AIR DRYER Voss	300003165	300003078
100308510	AIR DRYER Voss	300003165	300003078
9324000320	AIR DRYER Voss	300003165	300003078
9324000540	Air Dryer Voss	300003165	300003078
4324200240	AIR DRYER Voss	300003165	300003078
4324200250	AIR DRYER Voss	300003165	300003078
4324200260	AIR DRYER Voss	300003165	300003078



**All the Assy Replaced by 100306900 / 100307610**

# Air Dryer Serviceable parts

Serviceable Spares			Serviceable Spares		
Part number	Description	Figure	Part number	Description	Figure
100347851	Air Dryer Body - Voss		350026013	Top Cover Kit	
100311510	Unloader Plunger Assy		100334791	Top Cover	
100311480	Silencer Assy		9324009222	Screw with Screw Holder	







# DDU ASSY

Sl.No	Part No.	Description	Alternate Part No	Application	Repair Kit	Minor Kit
1	100304112	DDU – Double Bed – Thread	100304112	AL	MSP 3/96 & MSP 3/167	MSP 3/86
2	100304116	DDU – Double Bed – Thread		AL		
3	100304880	DDU – Single Bed – Thread	100304881	TATA 709 /909/1109		
4	100304881	DDU – Single Bed – Thread				
5	100304941	DDU – Single bed – voss – 2hole	100304941	TATA HCV / MAHINDRA	MSP 3/98 & MSP 3/168	
6	100307510	DDU – Single bed – voss – 2hole				
7	100306250	DDU – Single bed – voss – 2hole				
8	100304943	DDU-(VOSS)	No Alternate	TATA HCV		
9	100305201	DDU	100305201	TATA HCV	MSP 3/96 & MSP 3/167	
10	100305552	DDU				
11	100305440	DDU – Single bed – voss – 3hole	9325000790	TATA 709 /909/1109	MSP 3/98 & MSP 3/168	
12	100305441	DDU – Single bed – voss – 3hole				
13	100305444	DDU – Single bed – voss – 3hole				
14	9325000790	DDU – Single bed – voss – 3hole				
15	100305930	DDU – Double bed – Voss	100305930	AL HCV		
16	100306830	DDU – Double bed – Voss				
17	100307140	DDU-(VOSS)		TATA		
18	100307141	DDU-(VOSS)		TATA		
19	4324700290	DDU-(VOSS)		AL		



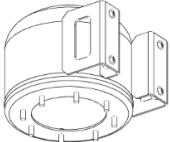

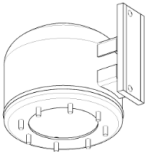
# DDU Serviceable Parts

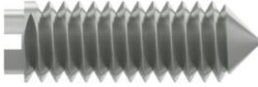
Serviceable Spares			Serviceable Spares		
Part number	Description	Figure	Part number	Description	Figure
100346954	DDU Body - Voss		100311730	Unloader Plunger	
100311690	Purge tank with 4 holes (Double bed)		100339471	QSPV Body	
100312240	Purge tank with 4 holes (Double bed)				
100312100	Silencer Assy		100336950	QSPV Screw	

Part no	Description	Major Kit	Minor Kit	QSPV Valve Kit	Plunger Assy
9325000000	APDA with QSPV	300003175	300003127	300003148	9325008202
9325000690	APDA with QSPV				
9325000720	APDA with QSPV				
9325000830	APDA with QSPV				
9325001160	APDA with QSPV				
9325001290	APDA with QSPV				
9325001320	APDA with QSPV				
9325001900	APDA with QSPV				
9325001880	APDA with QSPV				
9325002060	APDA with QSPV				
9325002540	APDA with QSPV				



**9325001960**





**9325001910**





Part No	Description	Catridge	Repair Kit	Plunger assy
9325001990	APDA with QSPV	300003170	9325009222	9347149272
9325002400	APDA with QSPV			
9325002280	APDA with QSPV			
9325001960	APDA with QSPV			

Part No	Description	Catridge	Repair Kit	Plunger assy
9325001910	APDA without QSPV	300003170	9325009222	9325001782

# APDA ASSY

ASSY's	WABCO Part No	Service kits	Fig
APDA With QSPV	9325001960 / 1290/ 000	9325009222 – Repair kit	
		9325002262 – Cartridge	
		9347149272 – QSPV repair kit	
APDA Without QSPV	9325001910	9325009222 – APU Repair kit	
		9325002262 – cartridge	

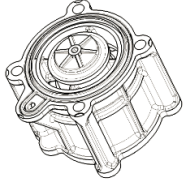
# APDA Serviceable Parts

Part No	Description	Assy's	Fig
9325008202	APDA Plunger kit	Old Type	
9325001782	APDA Plunger kit	New Type	
300003147	Silencer Kit	All APDA Assy's	

# AIR SYSTEM Protector



a



b



c

Part No	Description	Cartridge	Minor Repair Kit	Major Kit	Fig
4324203510	Air dryer with STD Cartridge	4324100202	4324200592	300003184	b
4324204510	Air dryer with STD Cartridge				b
4324200570	AIR DRYER	4329012232			a
4324200650	AIR DRYER				a
4324200660	AIR DRYER				a
4324200670	AIR DRYER				a
4324200680	Single-Chamber Air Dryer				a
4324200690	Air Dryer				a
4324200700	Air Dryer				a
4324200320	AIR DRYER WITH ASP				a
4324200340	AIR DRYER				a
4324200370	AIR DRYER				a
4324200380	Single-Chamber Air Dryer				a
4324107200	AIR DRIER				a
8840162020N	AIR DRYER				a
4324200290	Air Dryer with ASP+				4324102442
4324200300	Air Dryer with ASP+	c			



# Air Processing Unit



Part No	Description	Minor Repair Kit	Cartridge	Fig
4324150850	APU Without QSPV	4324150892	4329012232	a
4324150860	APU Without QSPV 10.6			a
4324150870	APU Without QSPV			a
4324151030	APU Without QSPV 10.6			a
4324150922	APU Without QSPV			a



Part No	Description	QSPV Kit	Minor Repair Kit	Cartridge	Fig
9325001510	Air Processing Unit with QSPV	9325001782	4324150922	4329012232	b
9325001520	Air Processing Unit with QSPV				b
9325001280	Air Processing Unit with QSPV				b
9325001220	Air Processing Unit with imported QSPV	4324159222			c
9325000980	Air Processing Unit with imported QSPV				c
9325000350	Air Processing Unit with imported QSPV				c
9325002320	Air Processing Unit with QSPV	300003148			b

# APU / ASP Serviceable Parts

Part No	Description	Fig
4324100202	ASP Std Cartridge (Black)	
4329012232	ASP Cartridge ( Silver)	
4324102442	ASP Plus (Gold)	

Part No	Description	Fig
4324070150	Silencer Assy	
4324070700	Silencer Assy	
9753036504	Top Cover	
9753034304	Screw Holder	
8102080164	Pressure Setting Screw	

# CROSS REFERENCE

ASSY's	WABCO Part no	KB Part No	Fig
Air System Protector	8840162020	B13TM1000169 / K172192	
Air Processing Unit without QSPV	4324150850/860	B13TM1000182N	
Air Processing Unit with QSPV	9325001510	B13TM1000182N	



# Unloader Valve

Part Number	Description	Repair Kit	Fig
100301910	UNLOADER VALVE WITH TI	300003049	a
100301920	UNLOADER VALVE WITH TI	300003049	a
100301940	UNLOADER VALVE WITH TI	300003049	a
100301950	UNLOADER VALVE WITH TI	300003049	a
100301970	UNLOADER VALVE WITH TI	300003049	b
100301980	UNLOADER VALVE WITH TI	300003049	b
100302270	UNLOADER VALVE WITH TI	300003049	b
100302300	UNLOADER VALVE WITH TI	300003049	a
100302310	UNLOADER VALVE WITH TI	300003049	a
100302450	AUTOMATIC DRAIN VALVE	300003049	a
100303410	UNLOADER WITH TYRE INFLATOR	300003049	a
100303430	Unloader Valve With Tyre Infla	300003049	a



**a**



**b**







# Oil Separator









Part No	Application	Major Kit	Minor Kit
100304780	All Models	MSP 3/112	MSP 3/122







# Hand Brake Valve Fast Moving part nos







MATERIAL	Description	OEM name
100305940	GRADUATED HAND CONTROL VALVE	ASHOK LEYLAND
100304980	GRADUATED HAND CONTROL VALVE	TATA
9611700040	GHCV with Self Return	TATA
100304950	GRADUATED HAND CONTROL VALVE	EICHER MOTORS
9611700010	GHCV with Self Return	ASHOK LEYLAND
9611700030	GHCV with Self Return	ASHOK LEYLAND
9617250020	Hand Brake Valve w/o TC	EICHER MOTORS
9611700050	GRADUATED HAND CONTROL VA	ASHOK LEYLAND
100303670	GRADUATED HAND CONTROL VALVE	ASHOK LEYLAND
100306860	Graduated Handcontrol Valve	EICHER MOTORS
9617010030	GHCV with bipolar switch	EICHER MOTORS
100303751	GRADUATED HAND CONTROL VALVE	ASHOK LEYLAND
9611700780	Hand Brake Valve, Truck NON SR	ASHOK LEYLAND
100308040	Graduated Handcontrol Valve	ASHOK LEYLAND
100303710	GRADUATED HAND CONTROL VALVE	ASHOK LEYLAND
100302990	Graduated Handcontrol Valve	ASHOK LEYLAND
9617250030	GHCV - NG	ASHOK LEYLAND
9611700020	GHCV with Self Return	TATA
100304960	G H CONTROL VALVE	M&M
9617250240	Hand Brake Valve, Truck/Trailer	TATA

<b>Hand Brake Valve</b>							
<b>Repair Kit</b>	<b>300003080</b>	<b>300003064</b>	<b>300003080</b>	<b>300003093</b>	<b>300003093</b>	<b>300003093</b>	<b>300003093</b>
<b>GHCV ASSY</b>	100303630	100302860	100303670	9611700780	100304950	100305940	100308040
	100303640	100302870			100304960		
	100303650	100305160			100304970	9617010030 (w/o Exhaust)	
	100303660	100302880		9611700650 (w/o exhaust)	100304980		
	100303751	100302890			100306860	9611700050	
	100305880	100305170					
<b>Application</b>	AL	TATA HCV / LCV	EICHER	Eicher	TATA	AL	Mahindra

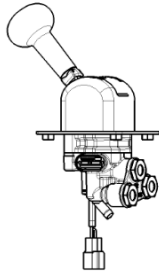
<p><b>Self Return GHCV</b></p>							
<p><b>Repair Kit</b></p>	<p><b>300003125</b></p>	<p><b>300003125</b></p>	<p><b>300003125</b></p>	<p><b>300003133</b></p>	<p><b>300003133</b></p>	<p><b>300003133</b></p>	<p><b>300003133</b></p>
<p><b>GHCV Assy</b></p>	<p>9611700020</p>	<p>9611700560</p>	<p>9611700010</p>	<p>9617250010</p>	<p>9617250030</p>	<p>9617251020</p>	<p>9617250040</p>
<p><b>Application</b></p>	<p>TATA</p>	<p>TATA / Eicher</p>	<p>AL</p>	<p>TATA / Eicher</p>	<p>AL</p>	<p>AL</p>	<p>AL / Eicher / Bajaj tempo</p>

# GHCV Assy

Self Return GHCV							
Repair Kit		<b>9617230012</b>	<b>300003133</b>	<b>300003133</b>	<b>9617230002</b>	<b>300003133</b>	<b>300003068</b>
GHCV ASSY	9617232030 (3 holes)	9617230010 (2 holes) 9617230640 (with connector)	9617241040	9617241050	9617231170 (voss)	9617251000 100306170 9617250110	100303710
	BEML	TATA		Bajaj tempo		BEML / Eicher	AL / SML

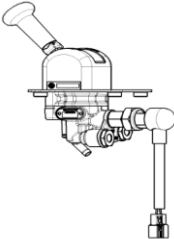
<p><b>Self Return GHCV</b></p>							
<p><b>Repair Kit</b></p>	<p><b>300003133</b></p>	<p><b>300003068</b></p>		<p><b>300003120</b></p>	<p><b>300003125</b></p>	<p><b>461700092</b></p>	<p><b>300003134</b></p>
<p><b>GHCV ASSY</b></p>	<p>9617250240</p>	<p>100304790 100303690</p>	<p>100300380</p>	<p>9611700060</p>	<p>9611700750</p>	<p>4617000000</p>	<p>9617250140</p>
	<p>TATA</p>	<p>AL</p>		<p>AMW</p>	<p>SML</p>	<p>ESCORT</p>	<p>AL</p>

# 4 Inch Clutch Servo

MATERIAL	Description	OEM name	Repair Kit	Type	Pushrod Length	Push rod Type	Alternate Part no
9700516440	4 inch Clutch Servo	TATA	300002037	4 inch	122	ball joint	9700516440
9700516480	TML Y1 ULTRA Clutch Servo 4 inch	TATA	300002056	4 inch	122	ball joint	
9700516230	Clutch servo	TATA	300002037	4 inch	122	ball joint	
9700516540	Clutch servo	TATA	9700513362	4 inch	122	ball joint	9700516200
9700516200	Clutch servo assembly	EICHER MOTORS	300002037	4 inch	125	ball joint	
9700516240	Clutch servo	TATA	300002059	4 inch	125	ball joint	
9700512750	Clutch servo	ASHOK LEYLAND	9700513242	4 inch	125	ball joint	
9700512730	Clutch servo	ASHOK LEYLAND	9700513222	4 inch	125	ball joint	
9700514910	Clutch Servo (DICV 4" 4 Bolt)	Daimler - India	300002037	4 inch	124.5	ball joint	9700514910
9700512510	Clutch servo	Daimler - India		4 inch	124	ball joint	
9700512460	Clutch servo(4")	Daimler - India	300002059	4 inch	124.5	ball joint	
9700512470	Clutch servo(4")	Daimler - India	300002059	4 inch	157.7	ball joint	9700514920
9700514920	Clutch servo	Daimler - India	300002045	4 inch	157.7	ball joint	
9700516430	Clutch servo	Daimler - India	300002059	4 inch	157	ball joint	
9700512490	Clutch servo(4")	Daimler - India	300002059	4 inch	157	ball joint	
9700514660	Clutch servo	Daimler - India	9700519712	4 inch	155	ball joint	
9700514950	Clutch servo	EICHER MOTORS	9700519612	4 inch	145	ball joint	100200750
9700514230	3 inch Clutch Servo	BEML	9700512882	4 inch	145	ball joint	
100200750	Clutch Booster 4"	#N/A	300002033	4 inch	145	ball joint	
9700516160	4 inch Improved Clutch Servo	TATA	300002037	4 inch	136	ball joint	9700516530
9700516520	Clutch servo	TATA	9700513362	4 inch	136	ball joint	
9700516530	Clutch servo	TATA	9700513362	4 inch	136	ball joint	
9700514250	Clutch servo	Daimler - India	9700519862	4 inch	127	ball joint	
9700516400	4 inch Clutch Servo	Daimler - India		4 inch	138	ball joint	
100200860	4 inch Clutch Servo	#N/A		4 inch			
9700514390	Clutch servo	OTHERS	9700519842	4 inch	53	ball joint	
9700515170	Clutch servo	TATA	300002049	4 inch	150	ball joint	
9700516300	Clutch servo	TATA		4 inch	170	ball joint	
9700516250	Clutch servo	TATA	300002037	4 inch	254	ball joint	
100200940	4" Clutch Servo	#N/A	300002033	4 inch			
9700512480	Clutch servo(4")	Daimler - India	300002059	4 inch	99.3	ball joint	
100200740	Clutch servo	BAJAJ TEMPO	300002033	4 inch	127	ball joint	





MATERIAL	Description	OEM name	Repair Kit	Type	Pushrod Length	Push rod Type	Alternate Part No
9700516220	4inch Improved Clutch Servo	TATA	300002037	4 inch	212	Yoke type	9700516220
100200850	4" Clutch Servo	TATA	300002033	4 inch	255	Yoke type	9700514980
9700516350	4 inch Clutch Servo	TATA	300002037	4 inch	255	Yoke type	
9700515130	4 inch Clutch Servo	TATA	300002037	4 inch	255	Yoke type	
9700514980	Clutch Servo 4inch Bolt to TML	TATA	300002037	4 inch	255	Yoke type	
100200950	SERVO BRAKE VALVE	EICHER MOTORS	300002033	4 inch	144	Yoke type	
9700516140	4inch-Clutch Servo(Cust.No.217829100102)	TATA	300002059	4 inch	239	Yoke type	
9700516340	4inch Improved Clutch Servo	BAJAJ TEMPO	300002037	4 inch	153	Yoke type	
9700512530	Clutch servo	Daimler - India	9700513412	4 inch	125	Yoke type	



# 3 Inch Clutch Servo

Part no	Description	OEM name	Repair Kit	Pushrod Length	Push rod Type	Alternate Part No
9700517560	Clutch servo	M&M	9700512772	150	ball joint	9700517750
9700517740	Clutch servo	ASHOK LEYLAND	300002062	150	ball joint	
9700517730	Clutch servo	ASHOK LEYLAND	9700513202	150	ball joint	
9700517750	Clutch servo	ASHOK LEYLAND	9700513202	150	ball joint	
9700514940	3inch Improved Clutch Servo	ASHOK LEYLAND	300002047	103.5	thread end	9700514940
9700515140	3" Clutch Servo with Voss	ASHOK LEYLAND	300002039	103.5	thread end	
100200810	3 inch Clutch Servo	ASHOK LEYLAND	300002032	105	thread end	9700516630
9700516630	3 inch Clutch Servo	ASHOK LEYLAND	300002039	140	Yoke type	
9700517760	Clutch servo	ASHOK LEYLAND	9700513202	140	Yoke type	
100201020	3 inch Clutch Servo	M&M / TATA	300002032	265	Yoke type	100201020
9700516470	Clutch servo	M&M	300002039	265	Yoke type	
9700517570	Clutch servo	M&M		265	Yoke type	9700516460
9700516460	Clutch servo	M&M	300002039	108.2	ball joint	
9700517580	Clutch servo	M&M	9700513202	108	ball Joint	
9700512350	Clutch servo	OTHERS		285	Yoke type	9700512360
9700512360	Clutch servo	SWARAJ MAZDA		285	Yoke type	
100200770	Clutch servo	AMW	300002032	111.5	ball joint	100200770
9700516190	3inch Clutch Servo with M12X1 Adaptor	EICHER MOTORS	300002039	115.5	ball joint	
9700516640	3 inch Clutch Servo	ASHOK LEYLAND	300002039	160	Yoke type	
9700516380	Clutch servo	ASHOK LEYLAND	300002032	148	ball joint	
9700514990	3 inch Clutch Servo with 3/2 Way Valve	ASHOK LEYLAND	9700519872	119	Yoke type	
9700516310	3inch Integrated Clutch Servo	EICHER MOTORS	300002039	250	Yoke type	
9700516320	Clutch servo	TATA	300002037	254	ball joint	
9700516560	Clutch servo	M&M	300002039	123.2	ball joint	
9700514930	Clutch Servo 3inch	ASHOK LEYLAND	300002032	137.5	ball joint	
9700512720	Clutch Servo-VECV	EICHER MOTORS	9700513142	83.5	ball joint	
9700516510	Clutch servo	TATA	9700513202	108	ball joint	
9700512450	Clutch servo	Daimler - India	9700513762	110.7	ball joint	



# 3 inch Eicher Clutch Servo's



**9700520050**



**9700520070**

## APPLICATION DETAILS:

Part No	Description	Application	OE Ref Part No	Competition Part No
9700520050	3" Clutch Servo - Spherical End	PRO 1110	ID316613	SM2719HL19
9700520070	3" Clutch Servo - Fork	PRO 1100	ID308189	SM2719HL13

# 3.5 inch Clutch Servo

Sl.No	Model	Variant	BS	Gear Box Type	Clutch Type
1	709	Tata LPT 709 EX2 Tata LPT 810 Ex2 Tata Ultra 814 Tata LPT 909 EX2	4	GBS 550 Synchromesh 6Forward & 1 Reverse	Single plate dry friction type-310 mm dia
2	1109	Tata LPT 1109/4ZH EX BS-III	3	GB40	Single plate dry friction type- 310 mm
3	1012	Tata ULTRA 1012/45WB	3	GBS 550	Single plate dry friction type-330 mm dia
4	1010 1014 1109 1412	Tata LPT 1010 CRX Tata Ultra 1014 Tata LPT 1109 EX2 Tata LPT 1109 HEx2 Tata Ultra 1412	4	GBS-550 Synchromesh (6F + 1R)	310 mm Dia, Single Plate Dry friction type(Booster-assisted)
5	912 1212 1412 1512	Tata LPK 912 Tata LPT 1212 CRX Tata LPK 1212 Tata LPK 1212 FET Tata LPT 1412 Tata LPT 1412 CRX Tata LPT 1412 CR SLP CAB Tata LPT 1512 CRX	4	GB40(8.02) rod shifting( Mechanical Linkage)( 5F + 1R)	Single plate dry friction type- 330 mm
6	1518	Tata Ultra 1518 Tata Ultra 1518 T Tata Ultra T.16S	4	GBS-750 DD (6F + 1R Synchromesh) Cable Shift	Single Plate Dry Friction Type, 352 mm



**9700520060 – GB 550  
Gear Box**

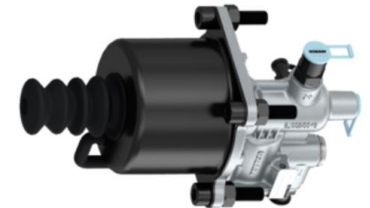

**9700520080 – GB 40 Gear  
Box**

# Wabco Clutch Master Cylinder

Internal

Fg. No	Part No	Descriptions	Applications	Major Kit	Minor Kit	OE Part No
1	4230540252	Clutch Master Cylinder	TATA			550743100110
2	4700530280	Clutch Master Cylinder	Bharat Benz 2523/ 3123	300002034	300002035	A4002950106
3	4700530310	Clutch Master Cylinder (Aluminium)	TATA Prima	300002034	300002035	288029300107
4	4700530320	Clutch Master Cylinder	Eicher			ID801650
5	4700530330	Clutch Master Cylinder	AL Boss	300002046		PN500001
6	4700530360	Clutch Master Cylinder	Mahindra			6802EAE00011N
7	4700530380	<b>Clutch Master Cylinder (29067430 &amp; 29068077)</b>	AL 2515, 3118, 3116, 4023	300002057		FN500600
8	4700530500	Clutch Master Cylinder	Mahindra BS VI	4700530932		6802EAE00011N
9	4700530530	Clutch Master Cylinder	AL Guru	30000204		PN500003
10	4700530650	Clutch Master Cylinder	AL BS VI	300002046		PN500005
11	4700531120	Clutch Master Cylinder	AL BS VI	4700539222		PN500007
12	4700531330	Clutch Master Cylinder	AL BS VI	4700539232		PN500006
13	9700015232	Clutch Master Cylinder (Plastic)	TATA Prima 4028/4928	300002038		500629300102
14	<b>4700538000</b>	<b>Clutch Master Cylinder</b>	<b>TATA (29066664, 29066577, 29067550 &amp; 20067342)</b>			

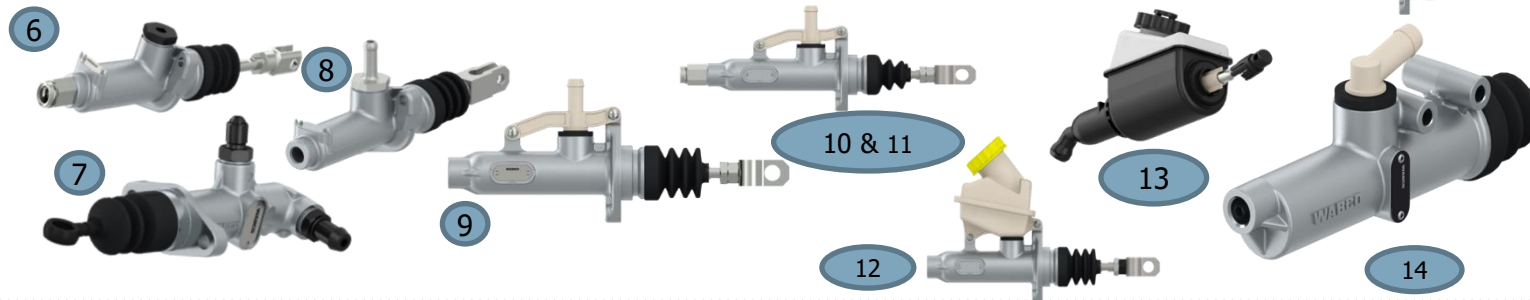

# Vacuum Booster

MATERIAL	Description	Make	Model	Major Kit	Minor kit	Diaphragm 1	Diaphragm 2	Ratio
100450210	VACUUM BRAKE VALVE	Tata Motors	407 SFC Pick up	300045008	300045002	100471980	-	5.0:1
100450610/11	VACUUM BRAKE VALVE	Tata Motors	407 SFC	300045013		100472460	100473640	
100450840	ZDS DDVBV 9+8	Tata Motors	Xenon	0				
100450620/21	VACUUM BRAKE VALVE	Tata Motors	407 LP / LPT	300045013		100472460	100473640	
100450850	Vacuum Brake Valve Dd 9+9	Force Motors	Tempo Traveller	300045020	300045022	100473910	100473950	
100450030	VACUUM BRAKE VALVE	Eicher	10.50,10.59,10.60G,10.70 & 10.79(Non Euro)/10.75	300045005		100470390		5:01
100450550	VACUUM BRAKE VALVE (9"+ 9")	Eicher	10.90(Euro II)	300045020	300045019	100473910	100473950	
100450350	DOUBLE DIAPHRAGM VAC. BRAKE VALVE	Swaraj Mazda	Super	0	300045017	100472460	100472490	5.7:1
100450480/81	10 Vacuum Brake Valve	Tata Motors	Sumo Victa	300045012		100473650		6.5:1
100450900	ZDS VBV 10"	Tata Motors	407/27WB BSIII Pickup	0				
100450820	DDVBV	Mahindra	25 Seater BUS	300045021	300045017	100473640	100472460	5.7:1
100450010	VACUUM BRAKE VALVE	Swaraj Mazda	T3500	300045003		100470390		4.1:1
100450570/71	ZDS DDVBV 9+8	Tata Motors	Tata Safari (Alu TMC)	300045013		100472460	100473640	6.7:1
100450130	VACUUM BRAKE VALVE	Tata Motors	407/608	300045001		100470130		3.6:1
100450500/01	DOUBLE DIAPHRAGM VAC BRAKE VAL	Tata Motors	Safari (ABS)	300045013	300045014	100472460	100473640	6.7:1
100450660	VACUUM BRAKE VALVE					100470130		
4624001000	9"+8" DDVBV & 1 1/8" TMC CV/CV Type							
100450680	Vacuum Brake Valve Dd 9+9	Mahindra	MIL Sherpa	300045019				
100450640	ZDS DDVBV 9+8							
100450230	VACUUM BRAKE VALVE	Force Motors	BTL Trax	300045007		100470130		4.1:1
100460060	NON RETURN VALVE ASSEMBLY							
4624000000	Double Diaphragm VBV 9+9 inch	Eicher		10.9	0			

# Integral Pedal unit – DBV + CMC Assy



# Integral pedal Unit

MATERIAL	Description	OEM name	Application	DBV	DBV REP KIT	CMC	CMC REP KITS
9650010950	G45 IPU BSVI	ASHOK LEYLAND	BSVI	4611001110	300006051	4700531120	4700539222
9650012100	Pedal Unit	ASHOK LEYLAND	BSVI	4611001110	300006051	4700531120	4700539222
9650012200	U-TRUCK IPU	ASHOK LEYLAND	U TRUCK	4611001110	300006051	4700531120	4700539222
9650011500	Integral pedal unit - G45	ASHOK LEYLAND	MDV/HCV	4611000970	300006051	4700530650	300002046
9619051000	Pedal Unit	ASHOK LEYLAND	HDT	4610010080	300006023	NA	NA
9650010370	AL-IPU NGICV	ASHOK LEYLAND	NGICV	4611000630	300006040	4700530330	300002046
9650010650	IPU ASSEMBLY	ASHOK LEYLAND	BOSS	4611000630	300006040	4700530330	300002046
9650012300	1PU-ICV	ASHOK LEYLAND	LYNX BSVI	4611001110	300006051	4700531120	4700539222
9650010880	AL BOSS 1616 IPU	ASHOK LEYLAND	BOSS 1616 BSVI	4611001220	300006040	4700531330	4700539232
9650010750	NGIT IPU	ASHOK LEYLAND	SUNSHINE	4611000860	300006040	4700530530	300002046
9650011900	IPU-BOSS 1920	ASHOK LEYLAND	BOSS 1920 BSVI	4611001220	300006040	4700531330	4700539232
9650012500	IPU-SUN SHINE	ASHOK LEYLAND	SUNSHINE BSVI	4611001170	300006051	4700531120	4700539222
9650010850	AL BOSS 1616 IPU	ASHOK LEYLAND	BOSS 1616	4611000940	300006040	4700530330	300002046
9650012970	MDV - IPU	ASHOK LEYLAND	BSVI	4611001290	300006051	4700531120	4700539222
8840593820	N-TRUCK IPU	ASHOK LEYLAND		4611001110	300006051	4700530650	300002046
9650010600	Pedal Unit	ASHOK LEYLAND	MDV/HCV	4611000630	300006040	NA	NA
9650012570	Pedal Unit + DBV	ASHOK LEYLAND		4611001110	300006051	NA	NA
8840800010	AL MDV E+2 IPU	ASHOK LEYLAND		4611000980	300006040	4700530920	
9650010851	IPU-BOS 1616	ASHOK LEYLAND		4611000940	300006040	4700530330	300002046
9650011800	IPU ICV BUS	ASHOK LEYLAND	G45 ICV BUS	4611000140	300006051	4700530650	300002046
9650012790	N-TRUCK IPU-AMT	ASHOK LEYLAND	N TRUCK	4611001290	300006051	NA	NA



# Integral pedal Unit

MATERIAL	Description	OEM name	Application	DBV	DBV REP KIT	CMC	CMC REP KITS
9650010700	IPU DICV	Daimler - India	2523 C	4611000900	300006023	4700530280	300002034
9650010270	Integral Pedal Unit	Daimler - India	2523, 3123	4611000130	4611001042	4700530280	300002034
9619051010	Brake Pedal Unit RHD	Daimler - India	914, 1214	4610010080	300006023	NA	NA
9650010430	Integral Pedal Unit	Daimler - India	4023, 4028, 4928	4611000130	4611001042	4700530280	300002034
9650010800	IPU DICV	Daimler - India	3128 C	4611000900	300006023	4700530280	300002034
9650010900	IPU	Daimler - India	HDT	4611000900	300006023	4700530280	300002034
9650010730	TML IPU	Daimler - India	BSVI	4611001250	300006051	4700530310	300002034
9650010620	IPU - DICV	Daimler - India	3143C, BSVI	4611000900	300006023	NA	NA
9650010930	DICV IPU	Daimler - India	BSVI	4613330060	Not Found	4700530280	300002034
9650010630	IPU-DICV - TB	Daimler - India	HDT	4611000900	300006023	NA	NA
9650010910	Pedal Unit +FBV+Clutch control	Daimler - India		4611000900	300006023	4700530490	
MATERIAL	Description	OEM name	Application	DBV	DBV REP KIT	CMC	CMC REP KITS
9650010440	Integral Pedal Unit - TML	TATA	PRIMA 2523	4611000100	300006023	4700530310	300002034
9650010490	IPU TML Variant	TATA	PRIMA 2523	4611000100	300006023	4700530310	300002034
9650010760	TML IPU	TATA	BSVI	4611001250	300006051	4700530310	300002034
9650010560	IPU TML Variant	TATA	PRIMA 2528	4611000710	4611001042	4700530310	300002035
9650010640	IPU	TATA	LPTA 2038	4611000100	300006023	4700530450	0
9650010740	TML IPU	TATA	BSVI	4611001260	300006051	4700530310	300002034
9650010570	IPU TML Variant	TATA	LPS 4928	4611000710	4611001042	4700530310	300002035
9650010280	Integral Pedal Unit	TATA	DEFENCE	100601220	300006027	9700015232	0
9650010940	MPV IPU-TML	TATA	MDV/HCV	4611000100	300006023	4700530310	300002034

# Brake Chamber



MATERIAL	Description	Description	Stand out	Diaphragm	Clamp ring
4231020040	Brake Chamber Ty.9	Type 9	72mm	100848401	100848781
100850400	BRAKE CHAMBER (TYPE 10.5)	Type 10.5	72mm	100870251	
100845320	Brake Chamber - Type 10	Type 10	72mm	100843120	9254553504
100850410	BRAKE CHAMBER (TYPE 12)	Type 12	72mm	100848651	100848791
4231030310	Brake Chamber - Type 12	Type 12	72mm	100848651	4231030004
100850960	Brake Chamber - Type 14	Type 14	72mm	100870031	100843890
100850291	BRAKE CHAMBER (TYPE 16)	Type 16	72 mm	100843220	100843890
4235140260	T14 Disc brake chamber	Type 14	72mm	8971215804	4231043514
4235140270	TY 14 Disc Brake chamber	Type 14	72mm	8971215804	4231043514
100850291	BRAKE CHAMBER (TYPE 16)	Type 16	72 mm	100843220	100843890
4235040080	Brake Chamber Disc-Type 16	Type 16	72 mm	8971205104	
4231050270	Brake Chamber 20		72mm	100843311	9253043504
4235050000	Brake Chamber Disc 20	Type 20			
4235100370	Brake Chamber Type 22	Type 22		4235100032	
4235100380	Brake Chamber Type 22	Type 22		4235100032	
4235100090	Brake Chamber- Type 22 Disc BC	Type 22		4235100032	
100850610	BRAKE CHAMBER (TYPE 24)	Type 24	72 mm	100843331	100275060
4231062540	Brake Chamber	Type 24	227mm	100843331	100275060
4231063200	Brake Chamber Type 24	Type 24	76mm	8971205354	4239053514
4231090360	Brake Chamber - Type 27	Type 27	72mm	8971200234	100870470
4231090680	Brake Chamber Type 27	Type 27	247mm	8971200234	
4231090710	Brake Chamber Type 27	Type 27	260mm	8971200234	4231090034
4231070280	Type 30 Brake Chamber	Type 30	72mm	8971205404	100870470
4231079000	Brake Chamber Cam 30	Type 30	186mm		

# LCV Spring Brake Actuator



MATERIAL	Description	OEM name	Description	Major kit	Stand out	Diaphragm	Cylinder
9254550040	SBA ty 12/12	Daimler - India	Type 12/12	300025065	72 mm	100848651	100260712
9254550030	Ty 12/12 SBA	TATA	Type 12/12	300025065	72 mm	100848651	100260712
100251600	SPRING BRAKE ACTUATOR	Daimler - India	Type 12/12	300025025	72 mm	100848651	100260712
9254550150	Ty 12/12 SBA	ASHOK LEYLAND	Type 12/12	300025098	72 mm	100848651	9254550222
100251260	SPRING BRAKE ACTR (TYPE 10.5/12)	#N/A	Type 10.5/12	300025032	72 mm	100848651	100260712
9253040460	Ty 16/16 SBA (TML)	TATA	Type 16/16	300025074	350mm	100843221	100261520
9253040530	Type 16/16 SBA	TATA	Type 16/16	300025092	350mm	100843221	100261520
9253045550	TY 16/16 SBA VECV	EICHER MOTORS	Type 16/16	300025092	72 mm	100843221	100261520
9253040440	T1616 SBA for TML	TATA	Type 16/16	300025123	72 mm	100843221	100261520
9253040730	TY 16/24 SBA M&M	M&M	Type 16/24	300025100	72 mm	100870191	9253040752
9253040190	SPRING BRAKE ACTUATOR (TY 16/24)-RH	ASHOK LEYLAND	Type 16/24	9253049222	72 mm	100870191	9259050242
9253040710	TY16/24 SBA 350mm	TATA	Type 16/24	300025095	72 mm	100870191	100261280
100251590	Spring Brake Acuator	ASHOK LEYLAND	Type 9/9	300025089	72 mm	100848401	100261121

# TWIST LOCK SBA 24/24



Internal

MATERIAL	Description	OEM name	Description	Major kit	Stand out	Diaphragm	Cylinder
9254910080	Tristop Cylinder 24/24 - SBA	ASHOK LEYLAND	Type 24/24	300025118	72 mm	100843331	9259076592
9254911560	Type 24/24 VE Assy	Daimler - India	Type 24/24	300025084	200mm	100843331	9259076592
9254911550	Type 24/24 VE Assy	Daimler - India	Type 24/24	300025084	200mm	100843331	9259076592
9254910750	Type 24/24 VE with 300mm	TATA	Type 24/24	300025118	300mm	100843331	9259076592
9254914350	SBA Ty 24/24	EICHER MOTORS	Type 24/24	9254912952	300mm	100843331	9259076592
9254914340	SBA Ty 24/24	EICHER MOTORS	Type 24/24	9254912952	300mm	100843331	9259076592

# TWIST LOCK SBA TY 27/24



MATERIAL	Description	OEM name	Description	Major kit	Stand out	Diaphragm	Cylinder
9254990230	Ty 27/24 SBA	AL	Type 27/24	300025077	72mm	8971200234	9253010242
9254990350	Type 27/24 SBA	AL	Type 27/24	300025077	260mm	8971200234	9253010242
9254990260	Tristop Cylinder 27/24	AL	Type 27/24	300025077	247mm	8971200234	9253010242

# HIGH FORCE ACTUATOR TYPE 24/24



Internal

MATERIAL	Description	OEM name	Description	Major kit	Stand out	Diaphragm	Cylinder
9254910480	TY 24/24 SBA WORLD TRUCK (75mmStroke)	TATA	Type 24/24	300025071	72mm	8971200054	9259050232
9254912550	T24242 SBA VECV PRO8000	EICHER MOTORS	Type 24/24	9254912952	72mm	8971205354	9254916692
9254913440	T2424 64mm ST 200mm SO	Daimler - India	Type 24/24	9254913682	200mm	8971205354	9253020232
9254913430	T2424 64mm ST 200mm SO	Daimler - India	Type 24/24	9254913682	200mm	8971205354	9253020232
9254913520	Spring Brake Actuator Type-24/24	TATA	Type 24/24	9254913742	275mm	8971205354	#N/A
9254913530	Spring Brake Actuator Type-24/24	TATA	Type 24/24	9254912952	350mm	8971205354	9254914062
9254911930	SPRING BRAKE ACTUATOR	ASHOK LEYLAND	Type 24/24	4231062282	230mm	8971205354	#N/A
9254911940	SPRING BRAKE ACTUATOR	ASHOK LEYLAND	Type 24/24	4231062282	230mm	8971205354	#N/A
9254910380	Spring Brake Actuator Type 24/24	EICHER MOTORS	Type 24/24	9254912952	101mm	8971205354	9254916692
9254913640	SPRING BRAKE ACTUATOR TY2424	EICHER MOTORS	Type 24/24	9254912952	76mm	8971205354	9254916692
9254990920	SPRING BRAKE ACTUATOR	ASHOK LEYLAND	Type 27/24	300025077	310mm	8971200234	9253010242
9254911930	SPRING BRAKE ACTUATOR	ASHOK LEYLAND	Type 24/24	4231062282	230mm	8971205354	#N/A
9254911940	SPRING BRAKE ACTUATOR	ASHOK LEYLAND	Type 24/24	4231062282	230mm	8971205354	#N/A

# HIGH FORCE ACTUATOR TYPE 27/24



MATERIAL	Description	OEM name	Description	Major kit	Stand out	Diaphragm	Cylinder
9254990080	Tristop Cylinder 27/24	EICHER MOTORS	Type 27/24	300025077	239mm	8971200234	9253020232
9254990500	T2724 SBA VECV PRO8000	EICHER MOTORS	Type 27/24	4231090982	255mm	8971200234	9254916692
9254990480/ 840	T2724 SBA VECV PRO8000	EICHER MOTORS	Type 27/24	4231090982	227mm	8971200234	9254916692
9254990950	TYPE 2724 SBA	TATA	Type 27/24	9254991232	275mm	8971200234	9253020232
9254991330	SPRING BRAKE ACTUATOR -	ASHOK LEYLAND	Type 27/24	300025017	310mm	8971200234	9253020232
9254991470	Spring Brake Actuator Ty.27/24	EICHER MOTORS	Type 27/24	9254999202	255mm	8971200234	9253020232
9254991610	Tristop Brake Actuator-Type	TATA	Type 27/24	9254991222	72mm	100870460	9253020232
9254991620	Tristop Brake Actuator - Type	TATA	Type 27/24	9254991222	72mm	100870460	9253020232
9254913450	SPRING BRAKE ACTUATOR	Daimler - India	Type 24/24	9254913682	72mm	8971205354	9253020232
9254913460	SPRING BRAKE ACTUATOR	Daimler - India	Type 24/24	9254913682	72mm	8971205354	9253020232
9254990920	SPRING BRAKE ACTUATOR	ASHOK LEYLAND	Type 27/24	300025077	310mm	8971200234	9253010242

# Spring Brake Actuator Type 30/30



MATERIAL	Description	OEM name	Description	Major kit	Stand out	Diaphragm
9253023330	T3024 SBA	ASHOK LEYLAND	Type 30/24	9253029222	175mm	8971200484
9253024440	T3024 Spring Brake Actuator	ASHOK LEYLAND	Type 30/24	9253029222	227mm	8971200484
9253020340	T3024 SBA	ASHOK LEYLAND	Type 30/24	9253029222		8971200484
9254920250	Type 3030 SBA	TATA	Type 30/30	9254929232		8971205404
9254921030N	Universal Tristop-Cylinder Cam 30/30	ASHOK LEYLAND	Type 30/30			
9253771100	DDSBA - TY-30/30	ASHOK LEYLAND	Type 30/30			
9253771000	Spg Brake Actuator Type 30/30	#N/A	Type 30/30			
9254922500	TY 30/30 SBA	ASHOK LEYLAND	Type 30/30			
9254921030	SPG BRAKE ACTUATOR TYPE 30/30-65MM STROK	#N/A	Type 30/30	9254920012		8971205404
9254921020	Universal Tristop-Cylinder Cam 30/30	Daimler - India	Type 30/30			



# TRAILER BRAKE CHAMBER

Part No	Type	Specification	Axle	Combo kit
100850690/700	TY 20	M14 Port 72mm std out/ 57mm stroke	AL	350030070
100850610	TY 24	M18 Port int adopter/72mm std out/57mm stroke	TATA/AL	350024121
9253771100	TY 30/30 DDSBA	m 16*1.5 / 75mm stroke	ALL	
4231061540	TY 24	175mm push rod/ 63.5 mm stroke	YORK	
4231061460	TY 24	175mm push rod/ 63.5 mm stroke	KROS	
4231070350	TY 30	253mm full thread/M16 adopter/63.5mm stroke	ALL	
4231061640	TY 24	No Full Thread,227mm with clevis / 63.5 mm stroke	FUWA/BPW	
4231062540	TY 24	Full thread for 227mm (M16*1.5)/63.5mm stroke	BPW	
4231061680	TY 24	Full thread for 110mm (M16*1.5)/63.5mm stroke	BPW	
100850850	TY 24	M18 Port int adopter/72mm std out/57mm stroke	TATA/MNAL	

# SBA SUB ASSY

Part No.	Vehicle Model	Type	Suitable Diaphragm	Suitable repair kit
MIK24/158	TML Cargo 909, Daimler 914 - Voss	12/12	M 848651	MSP 24/65
MIK24/159	TATA HCV - Non Voss	24/24	M 843331	MSP 25/24
MIK24/160	TATA HCV - Voss	24/24	M 843331	MSP 25/33
MIK24/161	AL HCV - Non Voss	20/24	M 843311	MSP 25/42
MIK24/162	TATA HCV - Voss	24/24	M 843331	MSP 25/33
MIK24/163	TATA 1109, EML 10.95,11.10 - Voss	16/24	M 848651	MSP 25/45
MIK24/164	AL boss 11 & 12 Ton - Non Voss	16/16	M 843221	MSP 25/74
MIK24/165	TATA HCV LATEST - Tristop - Voss	24/24	M 843331	MSP 25/84
MIK24/166	AL HCV latest - Tristop	24/24	M 843331	MSP 25/84



# SBA CYLINDER KITS



	Model	Repair Kit
MIK 24/38	Type 20/24 - AL	MSP 25/27
MIK 24/38	Type 24/24 - TML	MSP 25/24
MIK 24/46	Type 20/24 - AL	MSP 25/43
MIK 24/46	Type 24/24 - TML	MSP 25/33
MIK 24/97	Type 24/24 - Twist Lock	MSP 25/50 & MSP 25/84



Part No	Description
100843710	CLAMP RING BOLT Ty 240 & 24
100848960	CLAMP RING BOLT
8914900134	CLAMP RING BOLT



Part No	Description
100843720	CLAMP RING NUT-BC TYPE 16/24
8919900044	CLAMP RING NUT



## CLAMP RING KITS

350024050	Clamp Ring Kit (SBA 24/75)
350024051	Clamp Ring Kit New Type (SBA 20/24)
350024052	Clamp Ring Kit New Type(SBA 20/24)
350024070	Clamp Ring Repair Kit
350024073	Clamp Ring Repair Kit
350024079	Clamp Ring Kit
350024092	Clamp Ring Kit
350024104	Clamp Ring Kit SBA - (Type 16/16)
350024116	BC TY 16 CLAMP RING REPAIR KIT
350024154	SBA Type 16/16 Clamp Ring Repair Kit

# PUSHROD ASSY KIT

Part No	Description
350024047	PUSHROD ASSY KIT
350024054	Push Rod assy Kit(SBA 24/75)M251580/340
350024055	Push Rod assy Kit(SBA 20/24)M250790/800
350024056	Push Rod assy Kit(SBA 24/24)M250780
350024057	KIT: PUSHROD + FORK
350024071	PUSH ROD ASSY REPAIR KIT
350024074	Push Rod Assy Kit
350024105	Push Rod assy Kit SBA - (Type 16/16)
350024114	BC TY 16 PUSH ROD ASSY REPAIR KIT



# DUAL BRAKE VALVE

MATERIAL	Repair Kit	Repair Kit	Upper Body	Lower Body	Recommended Part No
100600180	300006019	300006020	100631854	100632004	100601670
100600190	300006017	300006018			
100600600		300006022			
100600681		300006052			
100600990	300006017	300006018			
100601040					
100601050		300006020			
100601670		300006020			
9618990330					
100601670		300006017			
4611000910		300006051	100632411	100632421	4611000910
100601000					
4611000830		300006051			
4611000790		300006051			
100601070		300006022			
100601060		300006022			
100600691	300006019	300006020			
100600690	300006019	300006020			
100600530	300006019	300006020			
4610010070		300006023			
100600641	300006019	300006020	100632751	100633032	100600781
100600781	300006019	300006021			
100600561	300006017	300006018			
100600581	300006017	300006018			

MATERIAL	Repair Kit	Repair Kit	Upper Body	Lower Body	Recommended Part No
100600900	300006023	300006024	100632971	100632951	4611000040
4611000040		300006023			
100601450	300006020	300006023			
100600910		300006052			
4611001240		300006051			
100601220		300006027			
4611000080		300006051	100632971	4611000974	4611001180
4611001180		300006051			
100601440		300006027	100632971	100632953	100601440
100600180	300006018	300006022	100630002	100630272	100600180
4611000980		300006040	100630162	100630122	4611000980
9618990350		300006052	100631850	100632000	9618990350
100600351	300006017	300006018	100631761	100632004	100600351
100600800			100631853	100633041	100600800
100601010		300006020	100632071	100631783	100601010
100600510		300006009			
100601020		300006020			
100601240		300006020			
4611000770		300006051	100632975	100632955	4611000770
4611000070		300006023			
100600740			100632680		100600740
4611001250		300006051		4619060914	4611001250
100601430		300006052	100632974	100632954	100601430
4611001130		300006051	100632974	100632954	4611001130
4611000090		300006023		4611000154	4611000090

MATERIAL	Repair Kit	Repair Kit	Upper Body	Lower Body	Recommended Part No
100601300					100601300
9618990340		300006052	100632983	100632961	9618990340
9618990300		300006024			9618990300
9618990310		300006052			9618990310
100601360		300006052			100601360
100601130					
100600920	300006052	300006024	100632981	100632961	100601130
100601560		300006036			
100601420		300006024			
100601660					
4611000120		300006051			
9618990360		300006052			
9618990320	300006024	300006052			
4610010080		300006023	100632981	4619060274	4610010080
4611000110		300006023	100633381	100632421	4611000110
100601150		300006024	100634101	100633621	100601150
4611000720		300006036			
4611000840		300006051	100634101	106336211	100601240
100601240		300006020	100634471	100631783	
100601550	300006052	300006024	100635141	4619060854	4611000660
4611000660		300006051			
4611000870		300006051			
4611000140		300006051			
4611000160	300006040	300006042	4619050115	4619050125	4611000160
4611000100		300006023	4611005505	100632951	4611000100
4611000130		4611001042	4611000174	4611000184	4611000130

MATERIAL	Repair Kit	Repair Kit	Upper Body	Lower Body	Recommended Part No
4611000710		4611001042	4611005505	100632953	4611000710
9618990430		300006045	4619060154	4619070104	9618990430
4611001230		300006053	4619060156	4619070104	4611001230
9618990450		300006052	4619060154	4619070104	9618990450
4611001220		300006040	4619060074	4619060064	4611001220
4611000900		300006023	4619060174	4619060164	4611000900
4610010050		300006020	4619060196	4619060186	4610010060
4610010060		300006020			
4611000920		300006051			
9618990410	300006054	300006042	4619060234	4619060224	9618990410
4611000730	300006053	300006042	4619060244	4619060224	4611000730
4611000860		300006040	4619060076	4619060064	4611000860
4611000940		300006040	4619060414	4619060404	4611000940
9618990480		300006052	4619060904	100632962	9618990480
9618990470		300006045	4619060584	4619060604	9618990470
4611001070	300006040	300006042	4619060634	4619060644	4611001070
4611001110		300006051	4619060814	4619060824	4611001110
4611001290		300006051			
4611000970		300006051	4619060514	4619060664	4611000970
4611001170		300006051			
4611001270		300006020	4619060934	4619060944	4611001270
4611000740		300006020	4619063004	4619063105	4611000740
9618990490		300006052	4619060964	4619060974	9618990490
4613186030			<u>4619030174</u>	<u>4619030176</u>	4613186030
4611001350			4619060934	4619060944	4611001350
4611001260		300006051	4619060914	4619060924	4611001260

## STOP LIGHT SWITCH



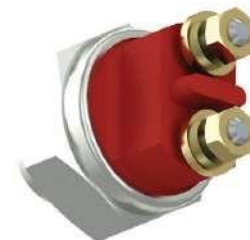

PART NO	DESCRIPTION	MAKE	MODEL
4410060140	Stop Light Switch	AL	BS VI
100250151	Stop Light Switch	AL /TML / MTWL	All Model
100250150	Stop Light Switch	AL /TML / VECV	All Model
4410010390	Stop Light Switch	DICV	HDT
100250450	Stop Light Switch	TML	All Model
4410010490	Stop Light Switch	TML	HCV



## LPW SWITCH



PART NO	DESCRIPTION	MAKE	MODEL
100252880	Low Pressure Indicator Switch	AL / VECV /MTWL	
100250040	Low Pressure Indicator Switch	AL /TML / BEML	All Model
100250520	Low Pressure Indicator Switch	BEML	
100250560	Low Pressure Indicator Switch	TML	909, 1109
100250280	Low Pressure Indicator Switch	TML / MTWL	All Model
100250561	Low Pressure Indicator Switch	TML / VECV	All Model- TML , VECV - 10 90, 1110





MATERIAL	Description	Repair Kit	Image	Recommended Part No
100302912	QUADR.SYS. PROT. VALVE (HI PR)-SCL	<b>300003065</b>		<b>9347020360</b>
100302921	QUADRUPLE SYSTEM PROTECTION VALVE			
100302910	QUADRUPLE SYSTEM PROTECTION VALVE			
100302911	QUADRUPLE SYSTEM PROTECTION VALVE			
100302920	QUADRUPLE SYSTEM PROTECTION VALVE			
9347020360	QSPV-MTBL			
9347020190	QSPV-DICV	<b>300003115</b>		<b>100307550</b>
100306330	QUADRUPLE SYSTEM PROTECTION VA			
100308110	QUADRUPLE SYSTEM PROTECTION VALVE			
100307550	QUADRUPLE SYSTEM PROTECTION VALVE			
100303760	QUADRUPLE SYSTEM PROTECTION VALVE			
100306750	Q.S.P. Valve			
100305860	Q.S.P.V (New)	<b>300003148</b>		<b>9347020840</b>
9347020840	QUADRUPLE CIRCUIT PROTECTION VALVE			
9347020730	Quadruple Circuit Protection Valve			
9347020780	Quadruple Circuit Protection Valve			
9347020320	Quadruple Circuit protection Valve			
9347020400	QUADRUPLE PROTECTION VALVE			
9347020370	Quadruple Circuit Protection Valve	<b>9347149272</b>		<b>9347140460</b>
9347020390	Quadruple Circuit Protection Valve			
9347140460	QUADRUPLE CIRCUIT PROTECTION VALVE			
9347140550	Quadruple Circuit Protection Valve			
9347141250	Quadruple Protection Valve			
9347140590	Quadruple Circuit Protection Valve			



# RG2 Relay Valve

MATERIAL	Description	OEM name	Alternate Part No	Fig
9732981230	RG2 RELAY VALVE	ASHOK LEYLAND	9732980280 / 9732981230 Three port connection Rep kit : 300003094	
100305850	RG2 RELAY VALVE			
9732981330	RG2 RELAY VALVE			
9732980280	RG2 RELAY VALVE			
9732981340	RG2 - Relay Valve	EICHER MOTORS		
9732981070	RG2 - Relay Valve	M&M		
9732980290	RG2 - Relay Valve	BAJAJ TEMPO		
9732981110	Relay Valve (RG2)	ASHOK LEYLAND		
9732981240	RELAY VALVE RG2	TATA		
100304930	RG2 Relay Valve			
9732981320	Relay valve, RG2		9732980180 Four port Voss Rep kit : 300003094	
9732980240	RG2 - Relay Valve	BAJAJ TEMPO		
9732981350	RG2 RELAY VALVE	BAJAJ TEMPO		
100307500	RG2 RELAY VALVE	M&M		
9732980260	RG2 - Relay Valve	M&M		
100306840	RG2 Relay Valve	#N/A		
100306270	RG2 Relay Valve	#N/A		
100308130	RG2 RELAY VALVE	#N/A		
9732981000	RG2 RELAY VALVE	ASHOK LEYLAND		
9732980180	RG2 RELAY VALVE			

# Relay Valve

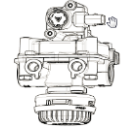
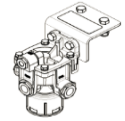
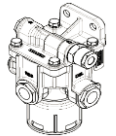
MATERIAL	Description	OEM name	Altenate Part No	Fig
100304430	RG2 - Relay Valve		9732981010 Adaptor Type	
9732981530	Relay Valve, RG2	TATA	9732981530	
9762001040	Relay Valve Package 3/2 Solenoid Valve	Daimler - India	9762001040	
8840591950	RELAY VALVE - RG2 WITH BRKT	ASHOK LEYLAND	8840591950	
4730170360	Relay valve - Select High	ASHOK LEYLAND	4730170360	

# Relay Valve Package



**9760000750**



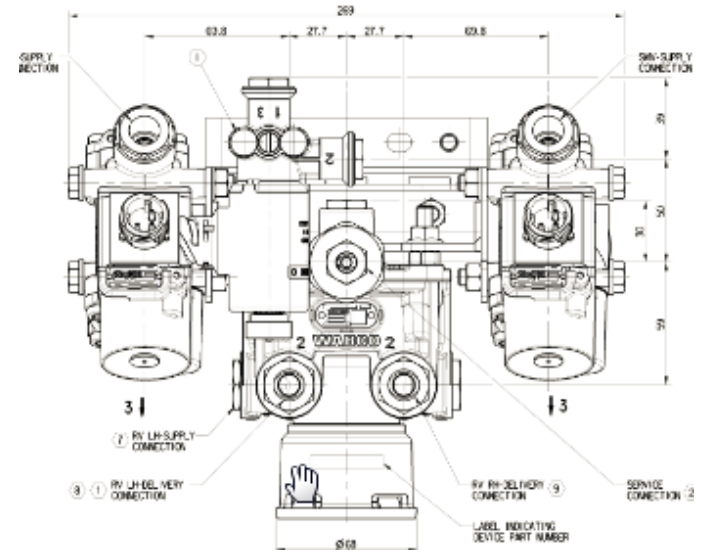

**9760000940**



**9760001180**

# R12 & R14 Relay valve

Part No.	DESCRIPTION	Repair Kit	Fig
100306080	R12 Relay Valve	MSP 3/79	
100308050	R12 Relay Valve		
9732981220	R12 RELAY VALVE		
9732981440	R12 RELAY VALVE		

Part No.	DESCRIPTION	Repair Kit	Fig
100306090	R14 Relay Valve (Vertical)	MSP 3/79	
100307220	R14 Relay Valve		
4730170100	R14 Relay Valve		
4730170090	R14 Relay Valve		
4730170120	R14 Relay Valve		

# Valves

## Trailer Control Valve:

Part No	Description	Recommended Part No	Repair Kit
100600040	Trailer Control Valve	No alternate	MSP 6/26
100601120	Trailer Control Valve	4731000010	
100601180	Trailer Control Valve		
100601370	Trailer Control Valve		
100601380	Trailer Control Valve		
100601530	Trailer Control Valve		
4731000010	Trailer Control Valve		

## Inversion Relay Valve:

Part No	Description	Recommended Part No	Repair Kit
100305420	Inversion Relay Valve	No alternate	MSP 3/87
100306060	Inversion Relay Valve	9718990000	
100307100	Inversion Relay Valve		
100307180	Inversion Relay Valve		
9718990000	Inversion Relay Valve		
9730150020	Inversion Relay Valve		



## RE6 Relay Emergency Valve

Part No	Description	Repair Kit
100300290	HM / All Trailers - Old (8 Port)	MSP 3/12
100302930	All Trailers - Latest (7 Port)	MSP 3/70
100302970	R6 Relay Valve (6 Port)	MSP 3/66

Combo Kit	
390026077	M302970 -2,M800601-1,M800611-1,M800621-1,M800631 -1
350030065	M302930 -1,M304501 -1
350030058	M302930 -1, M304430 -1



# QRV, PRV & Palm Coupling

## Quick Release Valve (QRV):

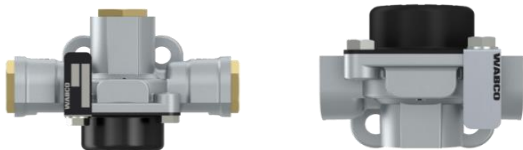

PART NO	APPLICATION
M304500 (MSP 3/89) & M302710 (MSP 3/63)	AL HCV / TATA
M304501 (MSP 3/89) & M302720 (MSP 3/63)	AL OLD VEHICLES
M304920 WITH 2 PORT VOSS (MSP 3/92)	TATA HCV
M305540 WITH 3 PORT VOSS (MSP 3/92)	AL / TATA

PART NO	DESCRIPTION
MIK 25	M 304500 With Adaptors
MIK 25/1	M 304501 With Adaptors



## Pressure Reducer Valve (PRV):

PRV	
Part No.	Repair kit
M306470( both side voss)	MSP 3/116
4750010080(one side voss &one side adaptor)	

## Palm Coupling:



PART NO	DESCRIPTION	REPAIR KIT
M 800600 / 601	TRACTOR (YELLOW)	MSP 8/53
M 800610 / 611	TRACTOR (RED)	
M 800620 / 621	TRAILER (YELLOW)	
M 800630 / 631	TRAILER (RED)	
M 800640	ASSY ( M 800600 + M 800620 )	
M 800650	ASSY ( M 800610 + M 800630 )	

# Automatic Load Sensing Valve

PART NO	DESCRIPTION	VEHICLE MAKE	APPLICATION	REPAIR KITS
100304300	Automatic Load Sensing Valve	AL	MDV /HCV	300003085
100307640	Automatic Load Sensing Valve	AL	MDV /HCV	300003099
4758000040	Automatic Load Sensing valve	AL	MDV /HCV	300003099
4757101280	Automatic Load Sensing Valve	AL / VECV / VOLVO	MDV /HCV	4757100022
4758000060	Automatic Load Sensing Valve	AL -VFJ	4757120000 / 40 / 50	300003085
4757110960	Automatic Load Sensing Valve	BEML	MDV /HCV	4757110002
100306200	Automatic Load Sensing Valve	MAN	MDV /HCV	300003099
100306800	Automatic Load Sensing Valve	MAN	MDV /HCV	300003099
4757110390	Automatic Load Sensing Valve	MAN	MDV /HCV	4757110002
4758000290	Automatic Load Sensing Valve	MAN	MDV /HCV	300003099
4758000450	Automatic Load Sensing Valve	MAN	MDV /HCV	300003099
4758000460	Automatic Load Sensing Valve	MAN	MDV /HCV	300003099
4758000470	Automatic Load Sensing Valve	MAN	MDV /HCV	300003099
4758000480	Automatic Load Sensing Valve	MAN	MDV /HCV	300003099
100306190	Automatic Load Sensing Valve	MAN	MDV /HCV	300003099
4758000280	Automatic Load Sensing Valve	MTWL	909 / 912 - BS IV	300003099
100306220	Automatic Load Sensing Valve	SML	MDV /HCV	300003085
100303550	Automatic Load Sensing Valve	TML	MDV /HCV	300003085
100303551	Automatic Load Sensing Valve	TML	1109	300003085
100304540	Automatic Load Sensing Valve	TML	3516 / 3015 / 4018	300003085
100306000	Automatic Load Sensing Valve	TML	MDV /HCV	300003099
100306010	Automatic Load Sensing Valve	TML	909, 1109	300003099
100306020	Automatic Load Sensing Valve	TML	909, 1109	300003099
100306710	Automatic Load Sensing Valve	TML	4928 /4938	300003099
100307600	Automatic Load Sensing Valve	TML	4928	300003099
4757210000	Automatic Load Sensing Valve	TML	MDV /HCV	300003099
4758000050	Automatic Load Sensing Valve	TML	MDV /HCV	300003099
4758000070	Automatic Load Sensing Valve	TML	MDV /HCV	300003099
4758000080	Automatic Load Sensing Valve	TML	E COMET 1012	300003099
4758000090	Automatic Load Sensing Valve	TML	4758000050	300003099
4758000270	Automatic Load Sensing Valve	TML	VFJ	300003099
4758000380	Automatic Load Sensing Valve	TML	MDV /HCV	1003060002
4757100022	Automatic Load Sensing Valve	VECV	MDV /HCV	300003099
4757110750	Automatic Load Sensing Valve	VOLVO	4757101280	4757110012



# LACV / LDV



PART NO	DESCRIPTION	VEHICLE MAKE	APPLICATION	REPAIR KITS
4631000020	Lift Axle Control Valve	DICV	3123, BS VI	300003176
4674000030	Load Detection Valve	DICV	3123	300003177
4631000000	Lift Axle Control Valve	TML	3118	300003155
4631000010	Lift Axle Control Valve	TML	3118	300003155
4631000620	Lift Axle Control Valve	TML	3118	4631000682
4674000010	Load Detection Valve	TML	3118	300003159
4674000020	Load Detection Valve	TML	3118	300003159
4674000180	Load Detection Valve	TML	3118	300003159
4631000630	Lift Axle Control Valve	TML	BS VI	4631000682



# TATA / SML / EML Brake Hose

Part No	Description	APPLICATION	OEM part Nos
3527130130	Hose Assembly	709 /LPT 1613,1510,909,2515,2518 / 1212/2523	261842900170
4526400900	Hose Assembly	LPT 2515,1618 Bsii Bsiii / 1623	257446800104
3527130160	Hose Assembly	SFC 909 / LPT 1109 /LPT 709 / LPT 1512 / 2515 / 4018	257342950177
3527130070	Hose Assembly	TATA 1618 / 1615 /1623 /1212 /1109 BSIII /Ultra 1412, 1518 BSIV / PRIMA	217143910190
3527130090	Hose Assembly	1109 / 712 / 709 BSIII / 1512 bSII	208546800101
3527130120	SML front brake hose	SML	LP493740A
3527130090	Brake Hose	EML	IA223074
3527130120	Brake Hose	EML	IA205866
3527130030	AC hose without adaptor	EML	IC309018
4526400210	AC hose with adaptor	EML	IA204213
3527130050	Hose Assy	One side bend M18 running nut	560mm/22inch
3527130060	Hose assy	One side bend M18 running nut	690mm/27inch
3527130100	Hose assy	Both side Straight M18 running nut	690mm/27inch
3527130110	Hose Assy	Both side Straight M18 running nut	760mm/30inch
3527130140	Hose assy	M18 Male Adaptor & M 18 running nut	760mm/30inch
3527130150	Hose Assy	M18 Male Adaptor & M 18 running nut	915mm/36inch

# ASHOK LEYLAND – REGULAR HOSE

Application	Length	End Fitting A	End Fitting B	Part Number
Brake hose Rear	600 mm / 23.6 Inch	M18 Running nut	M18 Running nut	100900750
	610 mm / 24 Inch	M18 Running nut	M18 Running nut	100902330
	680 mm / 26.7 Inch	M18 Running nut	M18 Running nut	100903460
Hand brake hose	600 mm / 23.6 Inch	M22 Running nut	M22 Running nut	100902020
	680 mm / 26.7 Inch	M22 Running nut	M22 Running nut	100903710
Brake hose - Fail safe Rear	600 mm / 23.6 Inch	M18 Running nut	M18 Male adaptor	100900350
Stallion hand brake hose	600 mm / 23.6 Inch	M22 Running nut	M22 Male adaptor	100902010
Brake hose BS-II,III,IV,VI Front	600 mm / 23.6 Inch	M18 Running nut	M14 Male adaptor	100900220
	610 mm / 24 Inch	M18 Running nut	M16 Male adaptor	100903730
	680 mm / 26.7 Inch	M18 Running nut	M14 Male adaptor	100902580
Crimped brake hose Rear	634 mm / 24.9 Inch	M18 Running nut	M18 Running nut	4526400850
Crimped hand brake hose	639 mm / 25.1Inch	M22 Running Nut	M22 Running Nut	4526400900
Crimped brake hose Front	638 mm / 25.1 Inch	M18 Running nut	M14 Male adaptor	4526400860
	718 mm / 28.2 Inch	M18 Running nut	M14 Male adaptor	4526400870
Air compressor hose	300 mm / 11.8 Inch	M22 Male adaptor	M22 Male adaptor	100900340
	375 mm / 14.7 Inch	M22 Male adaptor	M22 Male adaptor	100903720



# ASHOK LEYLAND – PUSH TYPE HOSES

Application	Length	End Fitting A	End Fitting B	Part Number
Brake hose BSIV & BSVI Rear	690 mm/ 27.1 Inch	Straight end with voss connector	Straight end with voss connector	4526400940
	790 mm/ 31.1 Inch	Straight End with Voss Connector	Straight End with Voss Connector	4526400710
Hand brake hose BSIV & BSVI	690 mm/ 27.1 Inch	Straight End with Voss Connector	Straight End with Voss Connector	4526400930
	790 mm/ 31.1 Inch	Straight end with voss connector	Straight end with voss connector	4526400690
Brake hose BSIV & BSVI Rear	656 mm/ 25.8 Inch	Straight end with voss connector	L bend with voss connector	4526400980
	756 mm/ 29.7 Inch	Straight end with voss connector	L bend with voss connector	4526400960
Hand brake hose BSIV & BSVI	656 mm/ 25.8 Inch	Straight end with voss connector	L bend with voss connector	4526400970
	756 mm/ 29.7 Inch	Straight end with voss connector	L bend with voss connector	4526400950

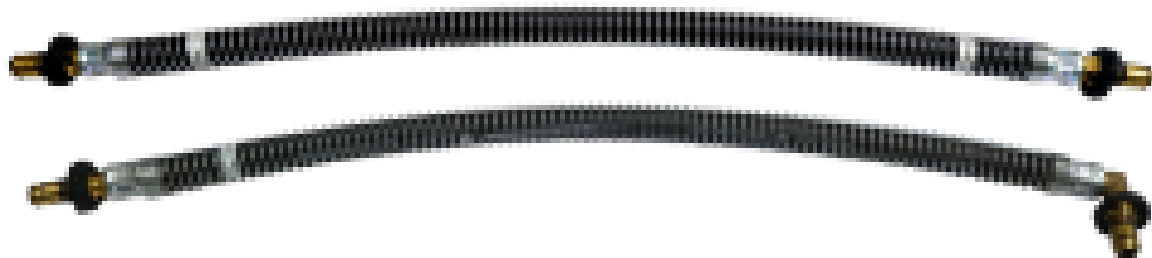

# TATA – BRAKE HOSE

Application	Length	End Fitting A	End Fitting B	Part Number
Brake hose BS- II,III Rear	607 mm / 23.8 Inch	M18 Running nut	M18 Running nut	100902560
	800 mm / 31.4 Inch	M18 Running nut	M18 Running nut	100903030
Brake hose BS- II,III Front	550 mm / 21.6 Inch	M18 Running nut	M18 Running nut with bend	100902570
	910 mm / 35.8 Inch	M18 Running nut	M18 Running nut with bend	100903770
Brake hose BS- IV Front	550 mm / 21.6 Inch	M18 Running nut	M18 Male adaptor with extra bend	100902970
Brake hose BS- III Front	600 mm / 23.6 Inch	M18 Running nut	M18 Male adaptor	100902960
Brake hose BS- IV,VI Front	498 mm / 19.6 Inch	M18 Running nut	M18 Running nut with bend	3527130080
	560 mm / 22 Inch	M18 Running nut	M18 Running nut with bend	3527130050
	690 mm / 27 Inch	M18 Running nut	M18 Running nut with bend	3527130060
	760 mm / 29.9 Inch	M18 Running nut	M18 Running nut with bend	3527130070
Brake hose BS- IV,VI Rear	460 mm / 18 Inch	M18 Running nut	M18 Running nut	3527130090
	610 mm / 24 Inch	M18 Running nut	M18 Running nut	3527130120
	690 mm / 27 Inch	M18 Running nut	M18 Running nut	3527130100
	760 mm / 29.9 Inch	M18 Running nut	M18 Running nut	3527130110
Brake hose (1613/ 1618)	760 mm / 29.9 Inch	M18 Running nut with bend	M18 Running nut with bend	3527130160
Brake hose (709,909,1613,1618)Front	690 mm / 27 Inch	M18 Running nut	M18 Male adaptor with bracket	3527130130
	760 mm / 29.9 Inch	M18 Running nut	M18 Male adaptor with bracket	3527130140
	915 mm / 36 Inch	M18 Running nut	M18 Male adaptor with bracket	3527130150
Air compressor Teflon hose (1616) BS- II	584 mm / 22.9 Inch	M22 Male adaptor	M22 Male adaptor	3527130030
Air compressor Teflon hose (1616) BS- IV	480 mm / 18.8 Inch	M26 Male adaptor	M26 Male adaptor	3527130020

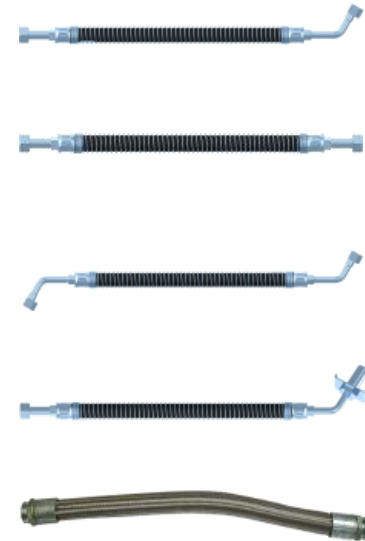

# Trailer Coiled Hose - Provia

Application	End Fitting A	End Fitting B	Part Number
Trailer hose – Emergency brake	M16 Male adaptor	M16 Male adaptor	PRO 7110560
Trailer hose - Service brake	M16 Male adaptor	M16 Male adaptor	PRO 7110570
Trailer hose - Emergency brake	M22 Male adaptor	M22 Male adaptor	PRO 7110580
Trailer hose - Service brake	M22 Male adaptor	M22 Male adaptor	PRO 7110590
Trailer hose - Emergency brake	M16 Male adaptor	M18 Running nut	PRO 7110600
Trailer hose - Service brake	M16 Male adaptor	M18 Running nut	PRO 7110610
Trailer hose - Emergency brake	M18 Running nut	M18 Running nut	PRO 7110620
Trailer hose - Service brake	M18 Running nut	M18 Running nut	PRO 7110630



# Brake Hoses Combo Part no (6 Nos)

Set Part No	Contains	Qty	LP	MRP	MOQ
4006092070	100900220	6	1180	1710	5
4006092250	100900340	6	1015	1470	5
4006092260	100900750	6	1515	2195	5
4006092270	100902020	6	2020	2930	5
4006092280	100902560	6	1740	2525	5
4006092290	100902570	6	1965	2850	5
4006092300	100902580	6	1545	2240	5
4006092310	100903460	6	2470	3580	5
4006092320	100903710	6	2275	3300	5
4006092330	100903720	6	1405	2035	5
4006092340	3527130050	6	1485	2155	5
4006092350	3527130060	6	1795	2605	5
4006092360	3527130070	6	2020	2930	5
4006092370	3527130100	6	1795	2605	5
4006092380	3527130130	6	1795	2605	5
4006092390	3527130140	6	2215	3210	5
4006092400	3527130160	6	2020	2930	5



# NYLON PIPE WITH SLEEVE – 50 Meter Role



S.No	Part No	Application
1	MIK 30/ 60	Polyamide pipe 12 mm OD with sleeve ( 50 Mtrs length)
2	MIK 30/ 61	Polyamide pipe 6 mm OD with sleeve ( 50 Mtrs length)
3	MIK 30/ 148	Polyamide pipe 8 mm OD with sleeve ( 50 Mtrs length)
4	MIK 30/ 149	Polyamide pipe 15 mm OD with sleeve ( 50 Mtrs length)



# Metal Connectors

Metal Connectors			
Sl. No	Part Number	Description	Qty Packed
1	350009040	Connector for 6mm Nylon Pipe with inserts	5 nos
2	350009041	Connector for 12 mm Nylon Pipe with inserts	5 nos
3	350009042	Connector for 15mm Nylon Pipe with inserts	5 nos
4	350009043	Connector for 8 mm Nylon Pipe with inserts	5 nos
5	350009032	T Connector 6 mm	5 nos
6	350009033	T Connector 12 mm	5 nos



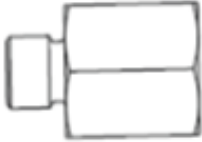

# VOSS CONVERTOR

ADOPTER DETAILS					VOSS KIT DETAILS	
						
SL NO	PART NO	A	B	A/F	MAJOR KIT (1,2,3,4,5)	MINOR KIT (1,2,4,5)
1	M932810	M12x1.5	NG8	22	MSP 3/129	MSP 3/123
2	M932840	M16x1.5	NG12	30	MSP 3/130	MSP 3/124
3	M932850	M22x1.5	NG12	30	MSP 3/130	MSP 3/124
4	M935520	M16x1.5	NG8	27	MSP 3/129	MSP 3/123
5	M936020	M22x1.5	NG8	30	MSP 3/129	MSP 3/123

# Manual Slack Adjuster

MEI Part No	WABCO Part No	Set of Four Part	Application
1801	100820220	390023038	TATA HCV
1802	100820230	390023039	TATA HCV
1803	100820240		TATA HCV
1827	100820270	390023040	TATA LCV
1828	100820280		TATA LCV
1829	100820260	390023041	TATA / EICEHR LCV
1810	100820250	390023037	AL



# Automatic Slack Adjuster

Sl.No	Part No	Description	Application	MEI PART NO
1	4332250850	ASA AL HCV straight 160mm 10 * 1.5 teeth	Ashok Leyland M/HCV Front /Rear	MEI SASA 340 MEI SASA 2230 MEI SASA 2340
2	4332250940	ASA 38 mm offset - LH 160mm 10 * 1.5 teeth	Ashok Leyland U Truck /Captain/12 Meter bus front	MEI SASA 1480
3	4332250950	ASA 38 mm offset - RH 160mm 10 * 1.5 teeth	Ashok Leyland U Truck /Captain/12 Meter bus front	MEI SASA 1490
4	4332250870	ASA 70mm offset - LH 140mm 10 * 1.5 teeth	Ashok Leyland Ecomet 1012 / 1212 / 9016 Rear	MEI SASA 1400
5	4332250880	ASA 70mm offset - RH 140mm 10 * 1.5 teeth	Ashok leyland Ecomet 1012 / 1212 / 9016 Rear	MEI SASA 1410
6	4332250440 500050006	ASA 140 38X1.5X24 straight M10 Hexagan nut	TATA M & HCV EICHER JUMBO / VE 2100 AMW Straight Mahindra & Mahindra HCV	MEI SASA 2120 MEI SASA 2280 MEI SASA 5070 MEI SASA 6630 MEI SASA 4720 MEI SASA 4710
7	4332250630	ASA LH 38X1.5X 24teeth 16mm offset	TATA / VECV M & HCV	MEI SASA 2130 MEI SASA 2290
8	4332250640	ASA RH 38X1.5X 24teeth 16mm offset	TATA / VECV M & HCV	MEI SASA 2140 MEI SASA 2300
9	4332250670	ASA 140 43mm Offset 38X1.25X24 LH	TATA HCV REAR	MEI SASA 310
10	4332250680	ASA 140 43mm Offset 38X1.25X24 RH	TATA HCV REAR	MEI SASA 320
11	4332250560 4332250840 4332250000	ASA 140 32X1.25X24 straight	TATA LCV 709/909/1009 Ashok leyland Stag/Lynx/Boss Volvo Eicher Front SML LCV	MEI SASA 2870 MEI SASA 2250 MEI SASA 2360
12	4332250570 4332250720	Automatic Slack adjuster (LH) 32X1.25X24	TATA LCV 709/909 Rear / Eicher	MEI SASA 2880 MEI SASA 2260



Sl.No	Part No	Description	Application	MEI PART NO
13	4332250580 4332250730	Automatic Slack adjuster (RH) 32X1.25X24	TATA LCV 709/909 Rear / Eicher	MEI SASA 2890 MEI SASA 2270
14	4332250400	ASA - LH 60mm offset 29deg inclination	AMW Tipper Rear R1 BSIII	MEI SASA 2480
15	4332250410	ASA - RH 60mm offset 29deg inclination	AMW Tipper Rear R1 BSIII	MEI SASA 2490
16	4332250420	ASA - LH 60mm offset 10 Splines	AMW Tipper Rear R1 BSII	MEI SASA 1250
17	4332250430	ASA - RH 60mm offset 10 Splines	AMW Tipper Rear R1 BSII	MEI SASA 1260
18	4332250980	ASA Straight 160mm 38X1.5X24	bharat benz M/HCV front Ashok leyland E Comet Front	MEI SASA 4130 MEI SASA 2950
20	4332251590	ASA 160mm 24X1.5X38 30degree Inclination	TATA 1616 bus / M&M HCV 37ton	
21	4332250500	ASA 160mm Straight 24X1.25X32	Ecomet 1112/ 1212/ HSD / AL /MTBL	MEI SASA 1360 / 4130 / 8350
22	4332250590/ 100820740	ASA 140mm Straight 10 Splines	AMW / Corona bus front	MEI SASA 2240
23	4332252340	ASA 160mm 38mm offset – RH 24X1.25X32	AL Utruck / captain	3500
24	4332252350	ASA 160mm 38mm offset – LH 24X1.25X32	AL Utruck / Captain	3510

# Modulator Valve

Part No	Description	Alter Part No
100592800	Modulator Valve 24v - Voss	4721951320
100595170	Modulator Valve 24v - Voss	
100594070	Modulator Valve 24v - Voss	
4721951320	Modulator Valve 24v - Voss	
4721951240	Modulator Valve 24v - ( Voss + Matric )	100597810
100595180	Modulator Valve 24v - ( Voss + Matric )	
100592820	Modulator Valve 24v - ( Voss + Matric )	
100597810	Modulator Valve 24v - ( Voss + Matric )	
100592520	Modulator Valve 24v Matric	100595870
100592930	Modulator Valve 24v Matric	
4721050180	Modulator Valve 24v Matric	
100592940	Modulator Valve 24v Matric	
100595870	Modulator Valve 24v Matric	
4721950160	Modulator Valve 24v Matric	



Part No	Description	Alter Part No
100592790	Modulator Valve 12v - Voss	100592790
4721950890	Modulator Valve 12v - Voss	
4721951200	Modulator Valve 12v - Voss	
100592810	Modulator Valve 12v - ( Voss + Matric )	4721950880
4721950880	Modulator Valve 12v - ( Voss + Matric )	
100592730	Modulator Valve 12v Matric	100592730
4721950660	Modulator Valve 12v Matric	

# ABS ECU / Modulator valve

MATERIAL	Description
4460046460	ABS ECU
9460040300	ECU ABS E4 BASIC 24V
9460046460	ECU ABS E4 Basic 24V
4460046530	ECU ABS BASIC 12V
100592630	Electronic Control unit - 24 V
9460046010	ECU ABS E4 Basic 24V
3460000030	VTS ECU
100592460	ENCLOSURE FOR ECU ..
9460046210	ECU ABS E Basic 12V KWP
100592580	ECU -24V,(WABCO PT NO:4460046220)
9460046020	ECU ABS Basic E4 12V
4460046340	ABS ECU
100594220	ECU -12V,(Wabco Pt No:4460046210)
100594040	ECU-24V( Wabco Pt No:4460046290)
100592620	ECU -12V,(WABCO PT NO:4460046210)
100594230	ECU -24V (Wabco No.4460046220)



MATERIAL	Description	OEM name
4410322060	Inductive sensor with HT tape L Type	ASHOK LEYLAND
4410322080	INDUCTIVE SENSOR WITH SOCKET & HT TAPE L Type	ASHOK LEYLAND
4410322070	INDUCTIVE SENSOR WITH HT TAPE STRAIGHT 2000mm	ASHOK LEYLAND
4410328210	WHEEL SPEED SENSOR L 1260mm	Daimler - India
100592530	Sensor (Wabco Pt No:4410321240) 2710mm L Type	ASHOK LEYLAND
4410322120	Straight sensor 2000mm	M&M
100594250	Wabco Pt No.4410329000-Sensor(St. type) 2000mm	ASHOK LEYLAND
4410328080	WHEEL SPEED SENSOR L type 400mm	ASHOK LEYLAND
4410329000	Sensor - St type 2000mm	ASHOK LEYLAND
4410322090	Sensor - St type 2000mm	ASHOK LEYLAND
8941103154	CONNECTOR HOUSING 3POLE(DT04-3P-P006)	TATA
8941102944	CONNECTOR HOUSING-16 POLE(1418984-1)	OTHERS
4410329710	Sensor - St type 2710mm	Daimler - India
4410328140	Wheel Speed Sensor- L Type	ASHOK LEYLAND

# Vacuum Exhaust Brake Valve Assy

PART NO	DESCRIPTION	VEHICLE MAKE	APPLICATION
4214292410	Vacuum Exhaust Brake Assembly	AL	LCV
4214290920	Vacuum Exhaust Brake Assembly	DICV	TF TITAN
4214291870	Vacuum Exhaust Brake Assembly	FML	LCV
4214290210	Vacuum Exhaust Brake Assembly	MTWL	LCV
4214290390	Vacuum Cylinder	MTWL	LCV
100450381	Vacuum Exhaust Brake Assembly	SML	LCV
100450390	Vacuum Cylinder	TML	LCV
100450400	Vacuum Cylinder	TML / VECV	LCV
100450122	Vacuum Exhaust Brake Assembly	VECV	LCV
100450341	Vacuum Exhaust Brake Assembly	VECV	Pro 1059
4214291850	Vacuum Cylinder	VECV	LCV
4214292140	Vacuum Cylinder	VECV	LCV
4214292150	Vacuum Exhaust Brake Assembly	VECV	BS VI 2049
4214293310	Vacuum Exhaust Brake Assembly	VECV	BS VI 2095
4214290360	Vacuum Exhaust Brake Assembly	Others	LCV





# LEVER CONTROL VALVE

PART NO	DESCRIPTION	VEHICLE APPLICATION	INLET	OUTLET
100800070	Lever Type Control Valve	BEML - BH 35	M10 X 1.5	M10 X 1.5
100800120	Shut Off Cock	AL / BEML - BH 40	M22 X 1.5	M22 X 1.5
100800130	Dummy Coupling/Shaktiman	AL /TML - VFJ	NA	NA
100800140	Shut Off Cock	AL - VFJ	M22 X 1.5	M22 X 1.5
100800180	Shut Off Cock	TML - LPTA 713	M22 X 1.5	M22 X 1.5
100800200	Lever Type Control Valve	HM - 2021 FEL	M12 X 1.5	M12 X 1.5
100800400	Lever Type Control Valve	CPIL - HM 2021	M10 X 1.5	M10 X 1.5
100800460	Lever Type Control Valve(Al)	AL - ALRD 20	M10 X 1.5	M10 X 1.5
100800500	Lever Type Control Valve	AL - VFJ	M10 X 1.5	M10 X 1.5
100800540	Lever Type Control Valve	AL - All Model	M12 X 1.5	M12 X 1.5
100800550	Lever Type Control Valve	AL - All Model	M10 X 1.5	M10 X 1.5
100800560	Lever Control Valve	TML - 1210	M12 X 1.5	M12 X 1.5
100800660	Lever Type Control Valve	AL - All Model	M10 X 1.5	M10 X 1.5
100800700	Lever Control Vale	VECV - All Model	M10 X 1.5	M12 X 1.5
100800710	Lever Type Control Valve	TML / VECV - All Model	M12 X 1.5	M12 X 1.5



# AIR SISPENSION

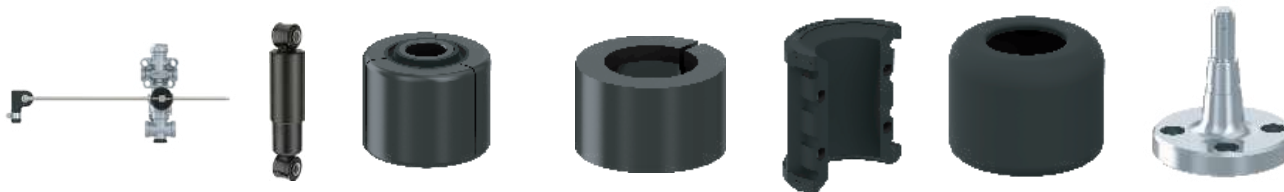

PART NO	DESCRIPTION	APPLICATION
4640060020	Levelling Valve	AL & TML
9515041450	Shock Absorber	AL & TML
9515040912	Rubber Bush - Conical	AL & TML
9515041314	Pivot Pin Split Bush	AL & TML
9515041412	ARB Rubber Pad Front	AL & TML
9515042324	Air Spring	AL & TML
9515040684	Tapper Pivot	AL & TML

## RETROFIT KITS

PART NO	DESCRIPTION	APPLICATION
9515040000	Air Suspension Retro Kit	AL 222 Viking
X370009069		
3900030142	Leveling Valve Retro Kit	AL & TML



PART NO	DESCRIPTION	APPLICATION
4461702270	ECAS ECU with CAN	TML - Hybrid Bus
4460555060	ECAS ECU	AL
4728800010	ECAS Solenoid Rear	TML - Hybrid Bus
4728800640	ECAS Solenoid Front	TML - Hybrid Bus
4728900410	ECAS Solenoid	AL
4410501000	Height sensor	TML - Hybrid Bus
4410507182N	Height sensor	AL
4410501200	Height sensor	AL
4410140250	ECAS Pressure Switch	AL / TML -Hybrid Bus
4729000092	Solenoid Valve Repair Kit	AL / TML -Hybrid Bus
4729009022	Solenoid Valve Repair Kit	MDV / HCV

# Diesel Exhaust Fluid





Part No	Description	Applications
8305000014 / 74	Diesel Exhaust Fluid - 20L	All BS VI & BS IV
8305000024 / 84	Diesel Exhaust Fluid - 210L	All BS VI & BS IV
8305000054 / 94	Diesel Exhaust Fluid - 1000L	All BS VI & BS IV
8305000034	Diesel Exhaust Fluid - 10L	All BS VI & BS IV

# REVERSE PARKING ASSIST SYSTEM

## PRODUCT FEATURES

- Consists of Control Box, 4 Parking Sensors, Buzzer & Cable Accessories
- Cable length 15 Mtr to 20 Mtr
- Entire system will work automatically when reverse gear is engaged
- Sensor kit will alter through “beep” when your vehicle is getting close to any barriers
- Customizable to meet AIS 145 regulation

		
PART NO	DESCRIPTION	APPLICATION
4462100120	Electronic Control Unit - RPAS	All Model

# AIR DISC BRAKE

PART NO	DESCRIPTION	VEHICLE MAKE	APPLICATION
6402251120	PAN 22 Caliper LH	General	AL 12Mtr Bus ( Retro fitted )
6402251130	PAN 22 Caliper RH	General	AL 12Mtr Bus ( Retro fitted )
40175068	PAN 17 ADB Caliper Assy LH	TML / AL / VECV /SML	Y1 ULTRA
40175069	PAN 17 ADB Caliper Assy RH	TML / AL / VECV /SML	Y1 ULTRA
4235140260	Brake Chamber Type 14 -Disc LH	TML	Y1 ULTRA
4235140270	Brake Chamber Type 14 -Disc RH	TML	Y1 ULTRA
4235060870	Brake Chamber Type 24 -Disc	AL	AL 12Mtr Bus ( Retro fitted )

## MAJOR SERVICEABLE PARTS

PART NO	DESCRIPTION	VEHICLE MAKE	APPLICATION
6409187484	Adapter LH PAN17	AL	OYSTER (EXPORT) / JANBUS Midi
6409187494	Adapter RH PAN17	AL	OYSTER (EXPORT) / JANBUS Midi
6622256214	Rotor Machined	AL	AL 12Mtr Bus ( Retro fitted )
6402250062	PAN22 ADB Brake Pad	AL	AL 12 MTR
6409187474	PAN 22 Adaptor plate	AL	AL 12Mtr Bus ( Retro fitted )
370009015	PAN 22 ADB Retro Kit -LH	AL	AL 12 MTR
370009016	PAN22 ADB Retro Kit -RH	AL	AL 12 MTR
12182183	PAN17 Brake Pad	All Model	PAN 17 Y1 ULTRA
3409020032	Brake pad kit	Meritor	PROVIA
6401757424	Adapter Plate-Machined	TML	PAN 17 Y1 ULTRA
6401757434	Adapter Plate-Machined	TML	PAN 17 Y1 ULTRA
6401759202	Clamping unit seals	TML	PAN 17 & PAN 22
6401759252	Wear Indicator Brake pads	TML	PAN 17 Y1 ULTRA
6621756194	Rotor - Machined	TML	PAN 17 Y1 ULTRA
3409010702	Brake pad kit	VOLVO	PROVIA
3409020002	Brake pad kit	VOLVO	PROVIA
3409022212	Provia Brake pad	VOLVO	PROVIA
3409020012	Brake pad kit	VOLVO	PROVIA

## RETROFIT KITS

PART NO	DESCRIPTION	VEHICLE MAKE	APPLICATION
370009015	PAN 22 ADB Retro Kit -LH	AL	AL 12 MTR
370009016	PAN22 ADB Retro Kit -RH	AL	AL 12 MTR

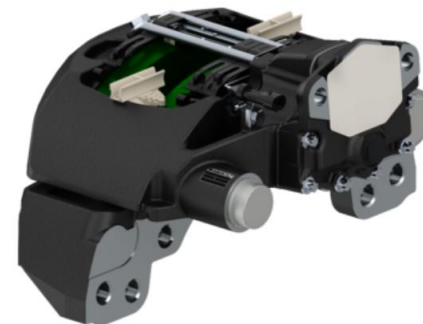

# MAGNETIC VALVES

Part no	Description	Remarks
5722600010	Magnetic Valve 24V	Inlet M16 Thread Voss / Other side M12
5722600020	Air Magnetic Valve with Bracket 12V	Both Side Voss
5722600050	Magnetic Valve with Bracket 24V	Both Side Voss
5722600240	MTBL Solenoid Valve 24V	Both side M14 X 1.5mm Male Thread
5722600320	Solenoid valve 12V	Both side M14 X 1.5mm Male Thread
5724600000	Magnetic Valve 12V	Both The side M12X1.5mm Male Thread
100305970	Magnetic Valve 12V	Inlet M16 Thread Voss / Other side M12 White Connector
100305971	Magnetic Valve 24V	Inlet M16 Thread Voss / Other side M12 White Connector
100303260	Magnetic Valve 12V	Both The side M12X1.5mm Female Thread
100303141	Magnetic Valve 24V	One side Inlet M12 female and M12 Male Thread
100303140	Magnetic Valve 12V	One side Inlet M12 female and M12 Male Thread
100303481	Magnetic Valve 12V	Both The side M12X1.5mm Female Thread

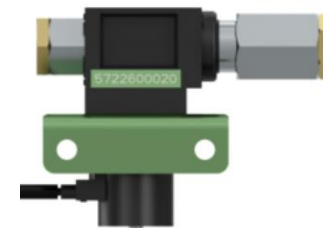
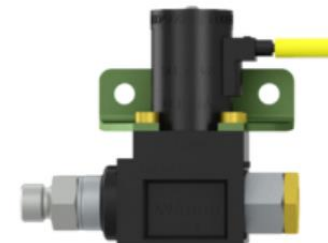
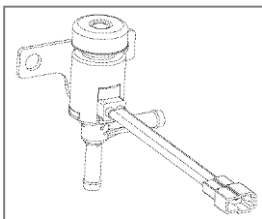

## M 304530 – Magnetic Valve TATA 407/SML

## 3/2 – Solenoid Valve

Material	Description	OEM name	Total
4721740080	Solenoid Valve -3/2	Daimler - India	24289
4721732260	3/2 Solenoid Valve	EICHER MOTORS	6459
4721710000	3/2 MAGNETIC VALVE	OTHERS	6164
4720706280	3/2 Solenoid Valve	BEML	5942
4721726000	SOLENOID 3/2	OTHERS	3421
4721752260	3/2 Solenoid Valve	TATA	2167
4721742260	3/2 Solenoid Valve	TATA	2148
4721740030	Solenoid Valve -3/2	ASHOK LEYLAND	1363



4721746160





# Vacuum Pump

MATERIAL	Description	OEM name	Total
9140300840	Vacuum Pump, Single-Vane	Mahindra	88489
9140300060	Vacuum Pump	Volkswagen	72730
9140300850	Vacuum Pump, Single-Vane	Mahindra Bolero	56833
9140300480	Vacuum Pump	Tata Ace	18519
9140300890	Vacuum Pump, Rotary Type	ASHOK LEYLAND	346

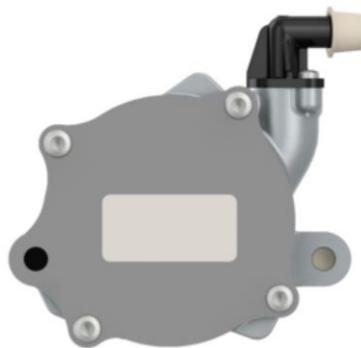

# Air Cylinder

MATERIAL	Description	OEM name	Total
4214290290	AIR CYLINDER	TATA	715681
100252151	Air Cylinder With Magnetic Val	TATA	646121
100252150	Air Cylinder with 12 V Mag Valve	TATA	455095
4214290660	AIR CYLINDER	TATA	89401
100250054	AIR CYLINDER WITH MAGNETIC VALVE	TATA	40604
4214290220	AIR CYLINDER	TATA	28198
100250052	AIR CYLINDER WITH MAGNETIC VALVE	TATA	14331
100250051	AIR CYLINDER WITH MAGNETIC VALVE	TATA	12544



# Door cylinder components

**MTS valve**



**63 Dia Door Cylinder**



**Emergency Push Button**



**50 Dia Door Cylinder**



**5/2 Mechanical valve**



**Self Plate**

# Door Control System – Variants with Part Numbers

S.No	Part no	Description
1	4729112920	JK Top Mounting with Obstacle Sensing System
2	4729112930	Inswing Door Bottom Mounting with Obstacle sensing system
3	4729112940	Outswing Door Top Mounting with Obstacle sensing system
4	4729112950	JK Bottom Mounting without Obstacle Sensing System
5	4729112960	JK Bottom Mounting With Obstacle sensing
6	4729112980	JK Double Door Bottom Mounting with Obstacle sensing
7	4729112990	Inswing Door Bottom Mounting Without Obstacle sensing system
8	4729113010	Outswing Door Top Mounting without Obstacle sensing system
9	Part No Yet to Release	JK Door Basic Variant ( hand Operated Valve)
10	Part No Yet to Release	Inswing Door Basic Variant ( hand Operated valve)

# EDC Switch & Pressure Sensor



**4410010522**



**8841014260**

# Pressure Test Connector

MATERIAL	Description	OEM name	Total
100303130	<b>PRESSURE TEST CONNECTOR M16 Female thread</b>	ASHOK LEYLAND	154828
100304200	<b>PRESSURE TEST CONNECTOR</b>	Daimler - India	491
100304202	<b>Pressure Test Connector M 16 male thread</b>	OTHERS	29175

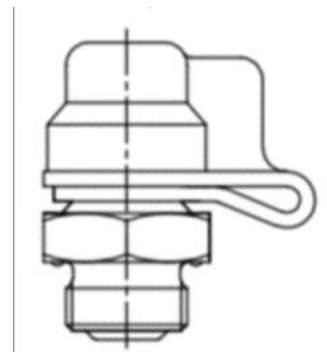

# Hose, Diaphragm, Drain Valve, SBA Kit & GHCV Set part numbers

Set Part Number	Contains	Qty	LP	MRP
4006092070	100900220	6	1180	1710
4006092250	100900340	6	1015	1470
4006092260	100900750	6	1515	2195
4006092270	100902020	6	2020	2930
4006092280	100902560	6	1740	2525
4006092290	100902570	6	1965	2850
4006092300	100902580	6	1545	2240
4006092310	100903460	6	2470	3580
4006092320	100903710	6	2275	3300
4006092330	100903720	6	1405	2035
4006092340	3527130050	6	1485	2155
4006092350	3527130060	6	1795	2605
4006092360	3527130070	6	2020	2930
4006092370	3527130100	6	1795	2605
4006092380	3527130130	6	1795	2605
4006092390	3527130140	6	2215	3210
4006092400	3527130160	6	2020	2930

Set Part Number	Contains	LP	MRP
4006094170	Set of 300025056-10nos	4350	6310
4006094180	Set of 100843331-10nos	3100	4495
4006094190	Set of 100848651-10nos	3150	4570

SET PART NUMBER	Contains	DESCRIPTION	LP	MRP
4006094140	100302830	Set of 100302830-15nos	1630	2365
4006094160	4343000090	Set of 4343000090-15nos	1630	2365

SET PART NUMBER	PART NO	DESCRIPTION	LP	MRP
4006093220	9611700010	GHCV Set of 4 nos 9611700010 (AL)	5760	8350
4006093230	9611700040	GHCV Set of 4 nos 9611700040 (TML)	5760	8350

# MOQ Part Numbers

Sl.no	Part no	Description	LP	MRP	MOQ	HSN code	GST Rate
1	390028006	SBA Non VOSS Set of 2nos	7270	21823	10	87169010	18%
2	390028007	SBA VOSS Set of 2nos	7270	20938	15	87169010	18%
3	390023037	MSA set of 4nos AL	3373	5048	25	87169010	18%
4	390023038	MSA set of 4nos TML	2859	4784	25	87169010	18%
5	390023039	MSA set of 4nos TML HCV Rear	3760	5450	10	87083000	28%
6	390023040	MSA set of 4nos TML LCV Rear	4025	5835	10	87083000	28%
7	390023041	MSA set of 4nos TML LCV Front	3110	4510	10	87083000	28%
8	390023042	MSA set of 4nos for DICV	3795	5503	10	87083000	28%

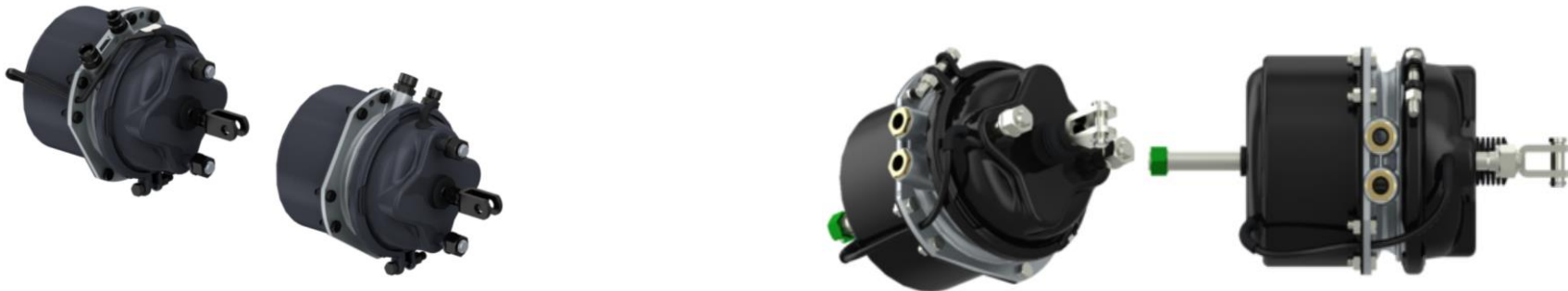



# COMPETITORS SUITABLE ASSY'S



**AIR DRYER**  
**8840162020N**



**HAND BRAKE VALVE**  
**9611700010**



**SYSTEM PROTECTION**  
**VALVE - M 307550**



**DUAL BRAKE VALVE**  
**M 601130 / M 600920**



**RELAY VALVE**  
**9730110040 with silencer**  
**9730110000 W/o Silencer**

# KB Vs Wabco Cross Ref

DESCRIPTION	KB AM Part No	KB PART NO.	Wabco Part No
FOOT BRAKE VALVE WITH PEDAL V	B13TM1000163	K002829/AM	100601130
FOOT BRAKE VALVE WITH PEDAL TML 2515	B13TM1001784	K071784	100600681
FOOT BRAKE VALVE WITHOUT PEDAL V	B13TM1002088	K092088/AM	100601130
FOOT BRAKE VALVE WITHOUT PEDAL TML 2515/2518	B13TM1002090	K092090	100600681
FOOT BRAKE VALVE - V WITH SWITCHES ALL	B13AL1004700	K023828/AM	4611000660
FOOT BRAKE VALVE	B13DI1000105	K045182	4611000130
FOOT BRAKE VALVE - V	B13MN1000230NFB	K046199/AM	4611000820
FOOT BRAKE VALVE - V	B13TM1000118	K051186/AM	9618990340
FOOT BRAKE VALVE - Split	B13TM1000180	K092629/AM	9618990340
FOOT BRAKE VALVE - Split	B13TM1000111	K077659/AM	9618990340
FOOT BRAKE VALVE - Split	B13TM1000111IN	K077659/IN	9618990340
HAND BRAKE VALVE	B13TM1000149	K047481	100302860
HAND BRAKE VALVE V Ver 1	B13TM1000151	HBVP06001/AM	9611700010
HAND BRAKE VALVE - V	B13TM1000152	HBVP06002/AM	9611700020
HAND BRAKE VALVE - V	B13TM1000154	HBVP06004/AM	9611700040
HAND BRAKE VALVE - V WITH LP SWITCH ALL	B13AL1004800	K023651/AM	100304950
HAND BRAKE VALVE	B13DI1000506	K045183/AM	9611700010
HAND BRAKE VALVE DPM 90	B13TM1000102HBV	HBVP07009XBT	9617241040
HAND BRAKE VALVE DPM 90 WITH TRAILOR CHECK	B13TM1000120HBV	HBVP07008XBT	9617250030
FOUR CIRCUIT PROTECTION VALVE - V	B13TM1000155	FCPVP06001/AM	9347020360
FOUR CIRCUIT PROTECTION VALVE - V - WITH COUPLING	B13AL1004400	K000669/AM	9347020360
FOUR CIRCUIT PROTECTION VALVE	B13DI1000406	K045181/AM	9347020360
FOUR CIRCUIT PROTECTION VALVE	B13TM1000142	FCPVP08006	9347020360
FOUR-CIRCUIT PROTECTION VALVE / TB	B13DI1005106	K091511N50	9347020360
RELAY VALVE - V	B13TM1000150	K003355/AM	9732981530
RELAY VALVE - V/M	B13TM1000113	RVP06001/AM	9732980970
RELAY VALVE - V/M	B13TM1000110	RVP06002/AM	9732981000
RELAY VALVE	B13TM1000158RV	RVP08002/AM	9732981000
RELAY VALVE	B13TM1000159RV	RVP08003/AM	9732980290
AC RELAY VALVE (IMP)	B13MN1000280N	K050295/AM	4730170100
AC RELAY VALVE (IMP)	B13TM1000175	ACRVP07001	4730170100
LEVELLING VALVE	B13TM1000401LV	K169121	390030142
LEVELLING VALVE	B13IM1000770	K194770N00	390030142

DESCRIPTION	KB AM Part No	KB PART NO.	Wabco Part No
DOUBLE CHECK VALVE	B13AL1000400DCV	K045288	4345000030
DOUBLE CHECK VALVE	B25AL1000100	K161818	4345000030
DRAIN VALVE	B13AM1000923	K207923	4343000010
AIR DRYER ASSEMBLY	B13TM1000169	K014963/AM	100307610
AIR DRYER V - 9 BAR	B13TM1000143	K035983/AM	100307610
AIR DRYER - V	B13TM1000151ADV	K028053/AM	8840162020N
AIR DRYER VOSS WITH TYRE INFLATOR, W/O HEATER	B13AL1004200	K023915/AM	100307610
AIR PROCESSING UNIT	B13TM0700109	K034367/AM	9325001510
AIR PROCESSING UNIT	B13TM100280N	K094317	9325001510
AIR PROCESSING UNIT W/O OSC	B13MN1000380N	K017466/AM	9325001510
AIR DRYER - 10.5 bar with external timer switch	B13TM1000182N	K172192	4324150850
COMPRESSOR 225CC TML	B30TM1001819	K071827	9129700180
MANUAL SLACK ADJUSTER FOR TATA HCV (FR)	K134681	K134681	390023038
MANUAL SLACK ADJUSTER FOR LEYLAND HCV (FR/RR)	k137061	K137061	390023037
MANUAL SLACK ADJUSTER FOR TATA HCV (RR) LH1613	K137081	K137081	390023039
MANUAL SLACK ADJUSTER FOR TATA HCV (RR) RH1613	K137083	K137083	390023039
AIR DRYER CARTRIDGE	B16TM1000414	K010414N50	4329012232
AIR DRYER CARTRIDGE FOR MNAL IMP 10 BAR	B16MN1000793	II17793	4329012232
AIR DRYER CARTRIDGE OSC	B16TM1000454	K095054N50	4329012232
LOAD SENSING VALVE WITH VOSS CONN. (TML)	B25TM1260247	K036489/IN	4674000010
LOAD SENSING VALVE WITH VOSS CONN. (TML) 37T	B25TM1260202	K081625	4674000010
PRESSURE LIMITING VALVE (TML PRIMA)	B25TM1260166	K034347/AM	100306470
PALM COUPLING - CONTROL - MTB (TRACTOR SIDE)	B18MN1000290N	K036229	100800600
PALM COUPLING - SUPPLY - MTB (TRACTOR SIDE)	B18MN1000300N	K036228	100800610
PALM COUPLING - SUPPLY - TML (TRACTOR SIDE)	B18TM1000118	PCP07002	100800600
PALM COUPLING - CONTROL - TML (TRACTOR SIDE)	B18TM1000119	PCP07001	100800610
PALM COUPLING - SUPPLY - TML (TRACTOR SIDE)	B18TM1000128	K091924	100800630
PALM COUPLING - CONTROL - TML (TRAILOR SDE)	B18TM1000129	K091925	100800620
TRAILER CONTROL VALVE (IMP)	B18MN1000260N	TCVP08002/AM	4731000010
TRAILER CONTROL VALVE	B18TM1000152TCV	TCVP07001/AM	4731000010
TRAILER CONTROL VALVE	B18TAM100100TCV	K134526	4731000010



Date

April 17, 2023

All customers

Sub: New Introduction of Part no:4006094770 - RE6 valve with Palm coupling

Dear Sir,

We are introducing the MOQ price for new part number 4006094770 with immediate effect

- MOQ quantity is applicable for single order – single branch only
- No TOD applicable & Scheme Price will be applicable till 30<sup>th</sup> June 2023

Part number	4006094770	MOQ	LP	MRP
Description	Combo Kit	>1	6420	14560
HSN	87169010	>50	6081	14560
GST	18%	>100	5743	14560

Component part number	4006094770	
Part number	Description	Qty
100302930	Relay emergency Valve	2
100800601	Palm Coupling	1
100800611	Palm Coupling	1
100800621	Palm Coupling (Trailer)	1
100800631	Palm Coupling (Trailer)	1

## Sub:- Set of 4 Cylinder kit

Dear Sir,

We are introducing the set of 4 SBA Cylinder kit with immediate effect

- MOQ quantity is applicable for single order – single branch only
- No TOD applicable & Scheme Price will be applicable till 30<sup>th</sup> June 2023

Set Part No	BOM Part No	Nos	List Price	MRP
4006094730	9253010242	4	2166	3140
4006094750	100261280	4	2166	3140
4006094760	100260652	4	2166	3140

The below mentioned WABCO CMC is made up of aluminum casting, which offers the following customer benefits, when compared with Cast Iron assembly.

#### Customer benefits on Aluminum body over Cast-iron body

- Anodized aluminum bodies 100% rust protected.
- 100% corrosion resistive compared to cast iron material (<240 hrs)
- 100% protection for all internal rubber seals resulting better life
- Higher shelf life
- Preferred choice of all OEM



Part No	Description	List Price	MRP	Application	Cross reference
4700538010	CMC with fork 25.4 mm for TATA HCV models	1158	1679	TML HCV Trucks, LPK 1615, LPK 1918 BS4, LPK 1923, SIGNA 1923 TIPPER, LPK 2523, LPS 3518 , LPT 1613, LPT 2518, SIGNA 2823 TK, SIGNA 3518.S, SIGNA 4018.S, SIGNA 3521 TRUCK, SIGNA 3718 TK, SIGNA 3718.T, SIGNA 4923.S, ULTRA 1518T, ULTRA 1918	503029100164 29067342

- HSN code:- 8708 & GST 28%